

Nolan.UDA



E4 Oct 2010

UPHOLSTERY FABRICS AND SUPPLIES

Nolan.UDA

Company Profile

On 3rd August 2009, the trading operations of Nolan O'Rourke and Co. Pty Ltd (trading as Nolan Warehouses) and Upholstering Distributors Australia Pty Ltd were merged into a 50-50 joint venture under the name Nolan.UDA Pty Ltd. Despite its relatively short history, Nolan.UDA has a proud legacy inherited from its parents Nolan O'Rourke and Co Pty Ltd, and Thomas Peacock and Sons Pty Ltd.

Nolan O'Rourke was established in 1920 by William Bernard Nolan, and is still third generation family owned. The company had its beginnings importing Motor Body Parts and Accessories, but over the years, it diversified first into Upholstery and Furnishing Supplies; then into the Industrial Textile and Contract and Commercial market sectors.

Upholstering Distributors Australia Pty Ltd (UDA) is itself a subsidiary of a fourth generation family company, Thomas Peacock and Sons, established in 1881. The principal operations of that group are the manufacture of bedding, and through other subsidiaries, the components of it, including expanded foam and lofted polyester.

The two businesses were well suited to merger. They were of similar size, operated in a like fashion, sold comparable (some identical) products to the same market segments in overlapping geographic areas.

Both were well established, had an excellent reputation and importantly, a high level of mutual respect, mainly because of similarities in their cultures and business approach. They complemented each other well, especially in terms of relative market penetration by both product type and geographic location. Substantial synergies and operational efficiencies have been realised through elimination of duplicate infrastructure and greater economies of scale.

In some market segments, the combined entity is the dominant market player, with all the potential commercial advantages that flow from that position. Our company prides itself on its technical expertise. Our team of sales representatives and customer service staff undertake extensive product and sales training to ensure they can provide the highest level of support and advice possible.

The company is classified a by the Australian Securities and Investments Commission (ASIC) as a 'Large Reporting Entity', satisfying the latter's minimum classification criteria of net assets and turnover. Total staff number eighty-two.

The merger has allowed the company to realise its ambition to become the leading wholesaler of outdoor textiles and related products to the Upholstery, Automotive, Marine, Industrial and Commercial market sectors. The business trades from seven fully stocked branches throughout Australia, located in Sydney (head office), Newcastle, Brisbane, Melbourne, Adelaide, Perth and Darwin.



NolanUDA sales team pictured outside the newly opened Brisbane warehouse in July 2010.

UPHOLSTERY FABRICS AND SUPPLIES

VOLUME 5 – TABLE OF CONTENTS

	Page		Page
INDEX & USAGE GUIDE	4	HOOK & LOOP FASTENING SYSTEMS	17-18
SUNBRELLA UPHOLSTERY FABRICS	5	ZIPPERS	19
SPRADLING UPHOLSTERY VINYLs	6	UPHOLSTERY BUTTONS	20
VYTEX UPHOLSTERY VINYLs	6-7	FINISHING STRIPS	21
LININGS & COVERS	8-9	THREADS	22-24
CUSHION INSERTS	9	TWINE	23
WADDINGS & UNDERLAYS	10	MARKERS	24
UPHOLSTERY FOAM	11-12	UPHOLSTERY TOOLS	25-27
UPHOLSTERY HARDWARE	13-15	UPHOLSTERY NAILS	27
SEATING WEBBING & ELASTIC TAPE	16	ADHESIVES	28-29
CARDBOARD & TRIM BOARD	17	SOLVENTS, CLEANERS & LUBRICANTS	30

USER INFORMATION

This upholstery catalogue is the fifth module of a series that makes up the master product catalogue of Nolan.UDA. Not all products are relevant to all customers, so the module concept has been developed to allow construction of a composite specific to a particular user need.

This volume is particularly relevant to re-upholsterers, furniture and bedding manufacturers.

Other volumes in the series comprise:-

Volume 1: INDUSTRIAL FABRICS

Volume 2: AUTOMOTIVE & MARINE

Volume 3: FASTENERS, FITTINGS & ACCESSORIES

Volume 4: CONTRACT & COMMERCIAL

Details of leather, seating upholstery vinyl and hospital mattress ticking can be found in volumes 2 & 4.

Page numbers are listed with the volume number as the prefix
eg V5.3 = Volume 5 page 3

INDEX AND USAGE GUIDE

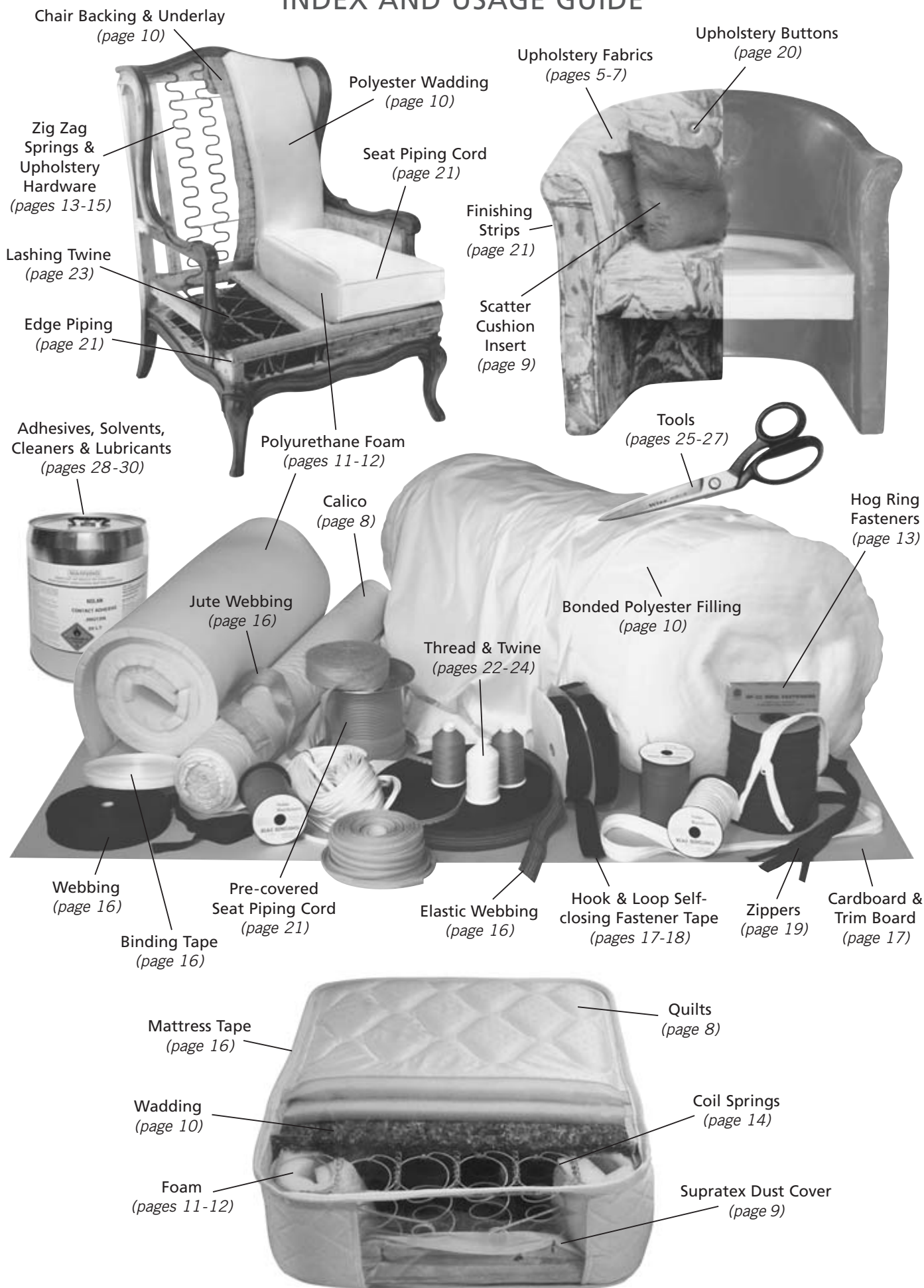

sunbrella® FURNITURE FABRICS

These beautiful and unbelievably durable fabrics were inspired by the proven performance of Sunbrella acrylic canvas, which has for years been used successfully in marine and awning applications. The outdoor environment is a harsh proving ground for any type of fabric. Not only does it need to be colour fast, stain and mildew resistant; but also easy to clean.

Sunbrella acrylic canvas wins on all counts. Colour fastness is the result of the acrylic yarn being solution dyed, which means the colour is an integral part of it, and not just impregnated into the surface. The surface treatment of the fabric, known as 'proofing', causes water to bead, therefore significantly improving the water penetration resistance. In an outdoor situation, this prevents leakage, but also enhances stain resistance, as it stops water borne contaminants from penetrating the yarn matrix. These are the reasons for Sunbrella's outstanding outdoor performance!



Formal lounge room incorporating Sunbrella fabrics. The seat cushions are completely washable.



"Mason Black" striped fabric, as good as new after two years on a verandah exposed to constant sunlight.

Apply this concept to an upholstery fabric, and you get something quite unique. Of course, Sunbrella furniture fabrics are not waterproofed, because they don't need to be. Nonetheless, the fabric can be used indoors or outdoors without risk. It will not be harmed by ultra-violet light, which can be so damaging to other types of fabrics.



Heavily mildewed fabric restored to almost pristine state after cleaning with diluted bleach and detergent, in accordance with the manufacturer's guide.

Cushion covers made from this fabric can be washed in an ordinary washing machine, if necessary with bleach added. The worst imaginable stains – wine, mustard, rust, mildew, nail polish, suntan lotion, ballpoint pen, etcetera - can all be successfully treated and removed. The fabric does not shrink, and dries remarkably quickly.

With the best will in the world, no family can prevent the attack on furniture covers by sticky fingered grandchildren, lounging adolescents, sports watching pie eaters or negligent party guests! At least with Sunbrella fabrics, despairing mothers can be confident that it just doesn't matter, and get on with the more important business of simply enjoying life. The fabrics are available in a wide choice of patterns and colours, and are supported with a five year warranty against loss of colour or strength from normal use, including exposure to sunlight, mildew and other atmospheric chemicals.



Some of the rich textures and patterns available.

PRODUCT DETAILS:

Weight: 270gsm (8oz/sq yd). Width: 137cm (54ins).
Sunbrella fabrics are available on indent order, either full roll (40 - 60 metres) or cut length. Sample cards are available from your nearest branch.

Key Product Features:

- 100% Solution dyed Acrylic fabric
- Colourfast and UV stable
- Soil and stain resistant
- Fully washable
- Five year warranty

SPRADLING UPHOLSTERY VINYL



Time and time again, after bitter experience flirting with traditional woven fabrics, specifiers return to vinyl for the real down and dirty commercial environments – hospitality and healthcare. From Doctor’s examining tables, to dentist’s chairs, to nursing home and hospital furniture, the three biggest problems are germs, abrasion and stains.

The answer is Spradling vinyl. It is economic, durable and easy to keep clean; but above all is extraordinarily hygienic. Chlorine, widely used in water treatment, is part of the molecular composition of vinyl, which gives it inherent ability to resist the growth of many bacterial organisms. With additional bactericides and fungicides added as standard in the formulation, Spradling’s “Contract Collection” resists the real nasties, such as Staphylococcus and E-coli. Hospital tests have proven it. Further, a range of sophisticated proprietary surface treatments such as “Permablok³”, “Permaguard” and “Silverguard” create yet another protective coating. No more worries about cross-infection and contamination.



Colour guides and product details for our full range of Spradling vinyls can be found in Volume 4, Section 4 of our catalogue, or on our website: www.NolanUDA.com.au



Spradling vinyls are inherently anti-bacterial, a key feature.



VYTEX UPHOLSTERY VINYL

IMPORTANT NOTICE

In 2009, the once great icon of Australian Industry, Nylex Corporation was placed into receivership, which threatened the continuity of supply of its well-known and proven quality furniture vinyl. Fortunately, Nolan.UDA the largest distributor of those vinyls in Australia, procured all the remaining stock, brand names and entered into ongoing contracts with its overseas suppliers. Further, former key technical staff were retained as consultants, for proper oversight of manufacture and quality control.

Therefore, the legacy lives on, and the core proven commercial upholstery brands of that entity – CORDOVA and CAPRI – have been re-launched under the recognisable masthead ‘Vytex’, and will continue to be available as before.

Other Commercial brands, namely Caesia, Designer Twill, Ecoweave and Otway, were scheduled for discontinuance prior to the takeover, but substantial stocks remain. We plan to continue these whilst stocks last, at very attractive pricing.

Vytex upholstery vinyl meets the flammability requirements for upholstery of the Building Code of Australia. Flammability test certificates are available on request.



Vytex Cordova used in a heavy duty commercial application.

VYTEX PRODUCT DETAILS (all available ex-stock):

Cordova: Weight: 670gsm. Width: 137cm. Roll Length: 30m

Capri: Weight: 615gsm. Width: 137cm. Roll Length: 30m

High quality commercial vinyl suited for all hospitality, healthcare and general commercial environments. Capri is also suited for outdoor use.

Key Product Features

- Durable and abrasion resistant
- Easy clean surface
- Soil and stain resistant
- UV stabilised
- Fire retardant
- Two year warranty

PRODUCT DETAILS





CORDOVA						
Colour						
Part #	20 COR LIN	20 COR RHU	20 COR CHE	20 COR SAN	20 COR STO	20 COR FER
Colour						
Part #	20 COR URB	20 COR JAV	20 COR BUR	20 COR DEE	20 COR COB	20 COR BLA
Colour						
Part #	20 COR DEL	20 COR PLA	20 COR SIL	20 COR COR	20 COR STE	
CAPRI						
Colour						
Part #	22 CAP EFF SIL	22 CAP FOA	22 CAP POL	22 CAP COR	22 CAP SAN	22 CAP COC
Colour						
Part #	22 CAP MOL	22 CAP DRI	22 CAP SUN	22 CAP MAN	22 CAP LOB	22 CAP PIS
Colour						
Part #	22 CAP TWI	22 CAP ATL	22 CAP SEAS	22 CAP PAC	22 CAP NEP	22 CAP REG
Colour						
Part #	22 CAP MOC	22 CAP OYS	22 CAP SEAG	22 CAP BAS	22 CAP INK	

PRODUCT DETAILS



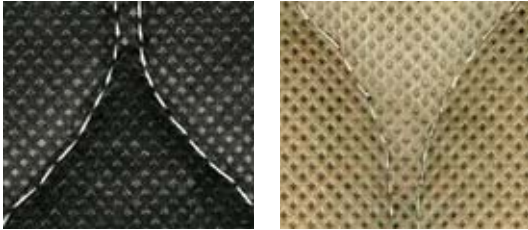

LININGS & COVERS

Colour	 Black	 Natural	 Black	 Brown
Product	COTTON CALICO		HERRINGBONE TWILL	
Part #	Black: 01CAL 137 BLA Natural: 01CAL 137 NAT		Black: 01TWI BLA 137 Brown: 01TWI BRO 137	
Details	Black: medium weight, 137cm wide x 250m rolls. Natural: heavy weight, 137cm wide x 150m rolls.		Twill pattern weave. Higher quality than calico. 137cm wide x 50m rolls.	

REVERSABLE QUILTS

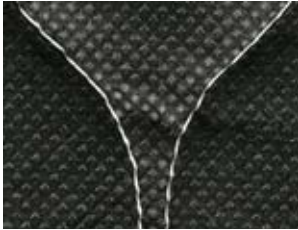
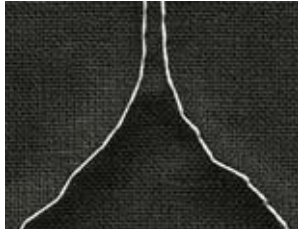
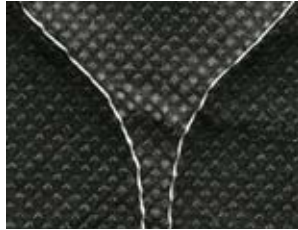
		
		
Product	SUPRAQUILT	PREMAQUILT
Part #	01QUI SUP BLA/BEI	01QUI PRE BLA/BRO
Details	Black/Beige synthetic calico (Supratex). 137cm wide x 25m rolls.	Black/Brown calico. 137cm wide x 25m rolls.

SINGLE SIDED QUILTS (used for spring pads)

			
			
Product	ECONOQUILT	CALIQUILT	POLYQUILT
Part #	01QUI ECO BLA	01QUI CAL BLA	01QUI POL BLA
Details	Black synthetic calico (Supratex). 137cm wide x 25m rolls.	Black calico. 137cm wide x 25m rolls.	Black synthetic calico (Supratex). 137cm wide x 25m rolls.

PRODUCT DETAILS

LININGS & COVERS (continued)

Product	 COMPOSITION TICKING	 NOVOFELTRO BASE COVER	 COVERWEAVE DUST COVER
Part #	<i>01TIC COM</i>	<i>01NOV BLA</i>	Grey: <i>01COV 093 GRY</i> White: <i>01COV 201 WHI</i>
Details	Pattern ticking for mattress covers. Subject to design and colour changes. 215cm wide x 100m rolls.	Felt dust cover for underneath seats. Weight: 100gsm. 150cm wide x 100m rolls.	Woven coated polyethylene. 250m rolls. Widths: Grey 93cm, White 201cm.

SUPRATEX DUST COVER

Synthetic Calico Spun Bonded

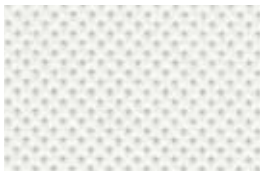
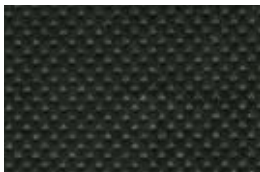

Weight	Colour	Width	Roll length	Part #
20gsm	White	240cm	100m	<i>01SUP 020 240 WHI</i>
40gsm	White	160cm	100m	<i>01SUP 040 160 WHI</i>
50gsm	Black	50cm	200m	<i>01SUP 050 50 BLA</i>
	Black	91cm	200m	<i>01SUP 050 91 BLA</i>
	Black	140cm	200m	<i>01SUP 050 140 BLA</i>
	Black	213cm	200m	<i>01SUP 050 213 BLA</i>
60gsm	White	229cm	200m	<i>01SUP 060 220 WHI</i>
75gsm	White	6cm	500m	<i>01SUP 075 006 WHI</i>
	White	16.5cm	500m	<i>01SUP 075 016 WHI</i>
	Black	105cm	200m	<i>01SUP 075 105 BLA</i>
	Black	145cm	200m	<i>01SUP 075 145 BLA</i>
	Beige	150cm	250m	<i>01SUP 075 150 BEI</i>
90gsm	Beige	213cm	100m	<i>01SUP 090 213 BEI</i>
100gsm	Beige	213cm	100m	<i>01SUP 100 213 BEI</i>
140gsm	Black	150cm	100m	<i>01SUP 140 150 BLA</i>

CUSHION INSERTS

Synthetic calico outer (ie Supratex) stuffed with loose polyester filling.

Available on East Coast	
Size	Part #
460mm x 460mm	<i>14SUD CUS INS 46</i>
510mm x 510mm	<i>14SUD CUS INS 51</i>
560mm x 560mm	<i>14SUD CUS INS 56</i>
610mm x 610mm	<i>14SUD CUS INS 61</i>

Available in WA, SA, NT	
Size	Part #
400mm x 400mm	<i>14PUD CUS INS 40x40</i>
450mm x 450mm	<i>14PUD CUS INS 45x45</i>
500mm x 500mm	<i>14PUD CUS INS 50x50</i>
550mm x 550mm	<i>14PUD CUS INS 55x55</i>
600mm x 600mm	<i>14PUD CUS INS 60x60</i>
650mm x 650mm	<i>14PUD CUS INS 65x65</i>

PRODUCT DETAILS

WADDINGS



LOOSE POLYESTER FILLING



SUPERFLOCK LOOSE FILLING



GREY NEEDED WADDING

Product	LOOSE POLYESTER FILLING	SUPERFLOCK LOOSE FILLING	GREY NEEDED WADDING
Part #	WA: 14WAD HOL NSW: 14SUD WAD LOO	14WAD SUP	14WAD NEE
Details	Sold per bale. Approx 30kg.	Sold per bale. Approx 30kg.	2 pads of 75 x 200cm per pack. 12 per bale.

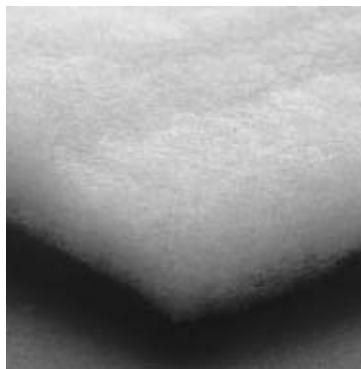

POLYESTER WADDING

Density	Width	Roll Length	Part #
Available on East Coast			
250gsm	150cm	25m	14SUD WAD 250 150
200gsm	150cm	25m	14SUD WAD 200 150
200gsm	200cm	30m	01 BRS POL DAC
Available in WA, SA, NT			
200gsm	147cm	25m	14PUD WAD 200 147
100gsm	147cm	40m	14PUD WAD 100 147

Product	POLYESTER WADDING
---------	--------------------------

UNDERLAYS



'LINTAS' COTTON PADDING



PREMIUM UNDERLAY



HESSIAN

Product	'LINTAS' COTTON PADDING	PREMIUM UNDERLAY	HESSIAN
Part #	14SUD WAD LIN	900gsm: 14UND AUT 900 1550gsm: 14UND AUT 1550	14oz: 01 HES 14 18oz: 01 HES 18
Details	Each pad 2kg in weight, approx 200cm x 100cm x 5cm. Sold by the bale of 25 pads.	183cm wide x 25m rolls. Weights: 900gsm & 1550gsm. Felted cotton.	183cm wide x 50m rolls. Weights: 14oz & 18oz.

For more information on the full range of Nolan.UDA products,
visit our website on: www.NolanUDA.com.au

USER GUIDE

Selection of Foam and Upholstery Filling

The comfort of a chair depends markedly on the quality of the unseen filling material – polyester/urethane foam and polyester wadding. In both materials, the key factor determining quality is density. In general, the higher the density, the greater the resilience (“bounce”), durability and degree of support. In foam, comfort is also affected by hardness, measured by the force in newtons required to attain a 40% deflection. The choice of the appropriate material depends on the application, but for upholstery seats a high resilient foam of density 31kg/m³ and hardness 190 (i.e. N31-190) is recommended by the manufacturer. For seat backs, a lighter density and hardness (N23-130) is suitable. There is some variation between states due to differences in production output, but these generally are the grades stocked by Nolan.UDA.

PRODUCT DETAILS

UPHOLSTERY FOAM



SHEET FOAM



ROLL FOAM



CRUMBED FOAM

Product	SHEET FOAM	ROLL FOAM	CRUMBED FOAM
Part #	Refer page V5.12	Refer specifications below	WA only: 14PUD CRU
Details	Available in six colour coded grades, from very hard to light. See over for code identification.	Medium density with a cerax backing suitable for seating cover underlay.	Sold in 10kg bags.

SPECIFICATIONS & AVAILABILITY

ROLL FOAM (Cerax backed)				CUSHION FOAM			
Available in SA, VIC, NSW				Available in SA			
Width	Roll Length	Thickness	Part #	Colour	Size	Thickness	Part #
1830mm	25m	6mm	14FOA ROL 006	Blue	510 x 510	100	14AUD CUS BLU510X510
1830mm	25m	9mm	14FOA ROL 009	Blue	610 x 560	100	14AUD CUS BLU610X560
1830mm	25m	12mm	14FOA ROL 012	Grey	510 x 510	100	14AUD CUS GRY510X510
Available in QLD				Grey	610 x 560	100	14AUD CUS GRY610X560
Width	Roll Length	Thickness	Part #	Available in QLD			
1830mm	25m	6mm	14BRS ROLL 6D	Colour	Size	Thickness	Part #
1830mm	25m	9mm	14BRS ROLL 9D	Green	510 x 510	100	14BUD CUS GRE510X510
1830mm	25m	12mm	14BRS ROLL 12D	SHEET FOAM			
Available in WA				Part numbers show density, hardness and width. eg Part # 14 PUD 23-130 100 23 = density (kg/m ³) 130 = hardness 100 = width (mm) Refer page V5.12 for specifications and availability.			
Width	Roll Length	Thickness	Part#				
1830mm	25m	9mm	14FOA ROL 009				
1830mm	25m	9.5mm	14PUD BAC 27-160 9.5				











PRODUCT DETAILS

SHEET FOAM – Specifications & Availability

Colour code: Mauve/Orange: Very hard, high density suited for sculpting shapes. Blue/Green: Premium grade suitable for upholstery seating, usually used in a marine environment. Yellow: Medium grade suitable for seat backs and mattresses. Grey: Light grade suitable for seat backs.				Available in QLD			
				Colour	Sheet Size	Thickness	Part #
				Green	2100 x 1850mm	25mm	14BRS GRE 25
				Green	2100 x 1850mm	50mm	14BRS GRE 50
				Available in all states except WA			
Green	2050 x 1850mm	12mm	14BUD 29-200 012	Green	2050 x 1850mm	75mm	14BUD 29-200 075
Green	2050 x 1850mm	100mm	14BUD 29-200 100	Available in NSW			
Green	2150 x 2060mm	6mm	14FOA GRE 31-190 006	Mauve	1830 x 910mm	13mm	14SUD 42-500 013
Green	2150 x 2060mm	12mm	14FOA GRE 31-190 012	Mauve	1830 x 910mm	25mm	14SUD 42-500 025
Green	2150 x 2060mm	25mm	14FOA GRE 31-190 025	Mauve	1880 x 1880mm	50mm	14SUD 42-500 050
Green	2150 x 2060mm	50mm	14FOA GRE 31-190 050	Mauve	2240 x 1980mm	50mm	14NTL PIN 50
Green	2150 x 2060mm	75mm	14FOA GRE 31-190 075	Available in WA			
Green	2150 x 2060mm	100mm	14FOA GRE 31-190 100	Blue	2070 x 1860mm	25mm	14PUD 31-180 025
Green	2150 x 2060mm	125mm	14FOA GRE 31-190 125	Blue	2070 x 1860mm	38mm	14PUD 31-180 038
Grey	2150 x 2060mm	25mm	14FOA GRY 23-130 025	Blue	2070 x 1860mm	50mm	14PUD 31-180 050
Grey	2150 x 2060mm	38mm	14FOA GRY 23-130 038	Blue	2070 x 1860mm	75mm	14PUD 31-180 075
Grey	2150 x 2060mm	50mm	14FOA GRY 23-130 050	Blue	2070 x 1860mm	100mm	14PUD 31-180 100
Grey	2150 x 2060mm	75mm	14FOA GRY 23-130 075	Black	2083 x 1880mm	75mm	14PUD 29-400 075
Grey	2150 x 2060mm	100mm	14FOA GRY 23-130 100	Yellow	2070 x 1860mm	6mm	14PUD 26-160 006
Available in SA				Yellow	2070 x 1860mm	13mm	14PUD 26-160 013
Mauve	1880 x 1880mm	25mm	14AUD 42-500 025	Yellow	2070 x 1860mm	19mm	14PUD 26-160 019
Mauve	1880 x 1880mm	50mm	14AUD 42-500 050	Yellow	2070 x 1860mm	25mm	14PUD 26-160 025
Orange	2000 x 1000mm	3mm	14AUD 20-100 003	Yellow	2070 x 1860mm	38mm	14PUD 26-160 038
Orange	2260 x 2070mm	25mm	14AUD 31-320 025	Yellow	2070 x 1860mm	50mm	14PUD 26-160 050
Orange	2260 x 2070mm	37mm	14AUD 31-320 037	Yellow	2070 x 1860mm	75mm	14PUD 26-160 075
Orange	2260 x 2070mm	50mm	14AUD 31-320 050	Yellow	2070 x 1860mm	100mm	14PUD 26-160 100
Blue	2057 x 1854mm	25mm	14AUD 35-200 025	Yellow	2070 x 1860mm	125mm	14PUD 26-160 125
Blue	2057 x 1854mm	50mm	14AUD 35-200 050	Grey	2070 x 1860mm	3mm	14PUD 23-130 003
Blue	2057 x 1854mm	75mm	14AUD 35-200 075	Grey	2070 x 1860mm	13mm	14PUD 23-130 013
Blue	2057 x 1854mm	100mm	14AUD 35-200 100	Grey	2070 x 1860mm	19mm	14PUD 23-130 019
Green	2057 x 1930mm	6mm	14AUD 31-190 006	Grey	2070 x 1860mm	25mm	14PUD 23-130 025
Green	2057 x 1930mm	13mm	14AUD 31-190 013	Grey	2070 x 1860mm	38mm	14PUD 23-130 038
Green	2057 x 1930mm	18mm	14AUD 31-190 018	Grey	2070 x 1860mm	50mm	14PUD 23-130 050
Green	2057 x 1930mm	25mm	14AUD 31-190 025	Grey	2070 x 1860mm	75mm	14PUD 23-130 075
Green	2057 x 1930mm	37mm	14AUD 31-190 037	Grey	2070 x 1860mm	100mm	14PUD 23-130 100
Green	2057 x 1930mm	50mm	14AUD 31-190 050	EXTRA HIGH LOAD FOAM (N38-200)			
Green	2057 x 1930mm	75mm	14AUD 31-190 075	Sheet Size	Thickness	Part #	
Grey	2057 x 1930mm	13mm	14AUD 23-130 013	2070 x 1860mm	25mm	14PUD END 38-200 025	
Grey	2057 x 1930mm	25mm	14AUD 23-130 025	2070 x 1860mm	50mm	14PUD END 38-200 050	
Grey	2057 x 1930mm	50mm	14AUD 23-130 050	REBONDED FOAM			
Grey	2057 x 1930mm	75mm	14AUD 23-130 075	1905 x 1570mm	25mm	14PUR REB C105 025	
EXTRA HIGH LOAD FOAM (N29-400)				1905 x 1570mm	50mm	14PUR REB C105 050	
Dk Grey	1830 x 910mm	25mm	14ADL CHA 25				
Dk Grey	1830 x 910mm	50mm	14ADL CHA 50				

PRODUCT DETAILS

UPHOLSTERY HARDWARE

Product	 48mm WEBBING END CLIP	 EK ZIG ZAG SPRING CLIP	 TWIST PINS
Part #	<i>01CLI WEB 48</i>	<i>01CLI SPR</i>	<i>01PIN TWI</i>
Details	Also known as Pirelli Webbing Clips.	Box of 100.	Box of 1,000.
Product	 CHRISTMAS TREE CLIPS	 TACK STRIP/TRIMFIX	 PLI-GRIP COVERFIX SHARK TRIM
Part #	30mm: <i>03CLI CHR 266-0007</i> 35mm: <i>03CLI CHR 266-0019</i>	<i>01TRI 27</i>	<i>01PLI COV</i>
Details	Sizes: 30mm with 20mm head, 35mm with 10mm head. Black. Bags of 100.	Box of 250. Length 27" (68.5cm).	30 metre rolls.
Product	 MATTRESS VENTILATOR	 CURVED NEEDLES	 REGULATORS
Part #	Nickel: <i>03 VEN 590.9.19.100</i> Brass: <i>03 VEN 590.9.19.731</i> Eyelet: <i>03 EYE ACE7.800</i>	Round point: <i>01OSB K3</i> Bayonet point: <i>01OSB K4</i>	10": <i>01 NEE REG 25 6G</i> 12": <i>01 NEE REG 30 6G</i>
Details	Supplied with ACE7 fastening eyelet in boxes of 2000.	Pack of 4 needles includes 3, 4, 5, & 6 inch.	Flat end needle used for tufting mattress. Sizes: 10" & 12".
Product	 STAPLES (80 series)	 HOG RING FASTENERS	
Part #	Galvanised: <i>03 AIR80 (size) GAL</i> Stainless Steel: <i>03 AIR80 (size) STA</i>	1,000 rows: <i>03 AIRRP 22</i> 5,000 rings: <i>03 AIRCL 22</i> 7kg pack: <i>03 AIRRL 22</i>	
Details	Sizes (mm) Galvanised: 4, 6, 8, 10, 12, 14. Stainless Steel: 4, 6, 10.	Available in box of 1,000, or 5,000 rings (magazine), or box of 7kg loose.	

PRODUCT DETAILS

UPHOLSTERY HARDWARE



ZIG ZAG SPRINGS

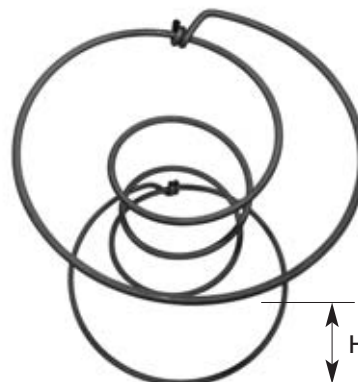

COIL SPRINGS

Thickness	Length (L)	Part #
2.80mm	36.5cm	01SPR ZIG 2.80 36.5
2.80mm	57cm	01SPR ZIG 2.80 57
2.80mm	Roll	01SPR ZIG 2.80 ROLL
3.43mm	36.5cm	01SPR ZIG 3.43 36.5
3.43mm	41cm	01SPR ZIG 3.43 41
3.43mm	51cm	01SPR ZIG 3.43 51
3.43mm	54cm	01SPR ZIG 3.43 54
3.43mm	55cm	01SPR ZIG 3.43 55
3.43mm	57cm	01SPR ZIG 3.43 57
3.43mm	59cm	01SPR ZIG 3.43 59
3.43mm	60cm	01SPR ZIG 3.43 60
3.43mm	61cm	01SPR ZIG 3.43 61
3.43mm	65cm	01SPR ZIG 3.43 65
3.43mm	Roll	01SPR ZIG 3.43 ROLL
4.00mm	57cm	01SPR ZIG 4.0 57
4.00mm	61cm	01SPR ZIG 4.0 61
4.00mm	64cm	01SPR ZIG 4.0 64
4.00mm	68cm	01SPR ZIG 4.0 68
4.00mm	79cm	01SPR ZIG 4.0 79
4.00mm	Roll	01SPR ZIG 4.0 ROLL

Thickness	Height (H)	Part #
2.8mm	125mm	01SPR COI 2.8 125
2.8mm	150mm	01SPR COI 2.8 150
2.8mm	175mm	01SPR COI 2.8 175
3.15mm	100mm	01SPR COI 3.15 100
3.15mm	125mm	01SPR COI 3.15 125
3.15mm	150mm	01SPR COI 3.15 150
3.15mm	175mm	01SPR COI 3.15 175
3.15mm	200mm	01SPR COI 3.15 200
3.55mm	175mm	01SPR COI 3.55 175
3.55mm	200mm	01SPR COI 3.55 200
3.55mm	225mm	01SPR COI 3.55 225
3.55mm	250mm	01SPR COI 3.55 250

Sold in bundles of 50.

Note: For fabric connection refer "Klinch it" tools and fasteners page V5.27

Details Sold in bundles of 100. Also available in roll form.

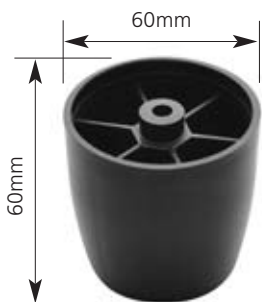

TUB LEG

SOFA LEGS & GLIDES

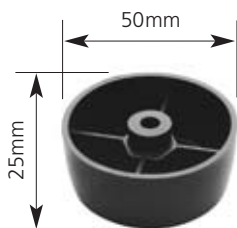

MINI TUB LEG



NAIL GLIDE

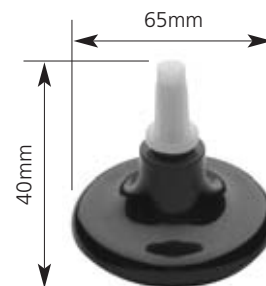

ROTO GLIDE

Part # 01LEG PLA TUB

01LEG PLA MIN

01CAS GUI NG2

01GLI BLA

SELF ADHESIVE FELT



Used on the underside of sofa legs and glides to protect the floor.

Width	Thickness	Roll Length	Part #
40mm	3mm	10 metres	01FEL BWPFLA

PRODUCT DETAILS

PRESS STUD DURABLE FASTENERS

BUTTON	Details	Finish/colour	Barrel Size	Box Quantity	Part #
	Use with durable socket <i>*Brass with plastic coated dome</i>	Nickel Plated Brass	3/16"	200 & 1000	03 DUR 636.100
			1/4"	200 & 1000	03 DUR 670.100
		Stainless Steel	1/4"	200 & 1000	03 DUR 582-1-13
		Black*	1/4"	200	03 DUR 670 PBLK
		Burgundy*	1/4"	200	03 DUR 670 PBUR
		Navy*	1/4"	200	03 DUR 670 PNVY
		White*	1/4"	200	03 DUR 670 PWHT
SOCKET	Details	Finish	Type	Box Quantity	Part #
	Use with durable button	Nickel Plated Brass	Easy Action	200 & 1000	03 DUR E548.100
			Common	200 & 1000	03 DUR C548.100
			Tight Action	200 & 1000	03 DUR T548.100
		Stainless Steel	Common	200 & 1000	03 DUR 582-1-3
			Tight Action	200 & 1000	03 DUR 582-1-5
STUD	Details	Finish		Box Quantity	Part #
	Use with durable eyelet	Nickel Plated	-	200 & 1000	03 DUR 550.100
		Brass Stainless Steel	-	200 & 1000	03 DUR 582-1-1
EYELET	Details	Finish	Barrel Size	Box Quantity	Part #
	Use with durable stud	Nickel Plated Brass	1/4"	200 & 1000	03 DUR 550A.100
			5/16"	200 & 1000	03 DUR 550C.100
		Stainless Steel	1/4"	200 & 1000	03 DUR 582-1-2
STUD	Details	Finish		Box Quantity	Part #
	Stud with 5/8" screw	Stainless Steel	-	100	03 DUR XN-103937

TOOLS



Button Die



Stud Die



Bench Die Holder

Product

03 DIE 1401

03 DIE 1407

03 TOO 194

Details

Use with 194 holder

Use with 194 holder

Use with 1401/1407

Product



Socket/Stud Hand Tool

Part # 03 TOO 164

FITTING GUIDE

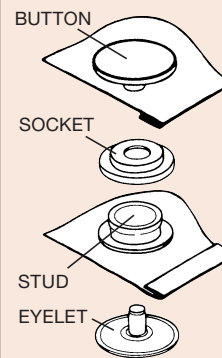

PRODUCT DETAILS

SEATING WEBBING & ELASTIC TAPE

ELASTIC WEBBING – Available in 100m rolls. Number of lines indicates grade and elasticity.

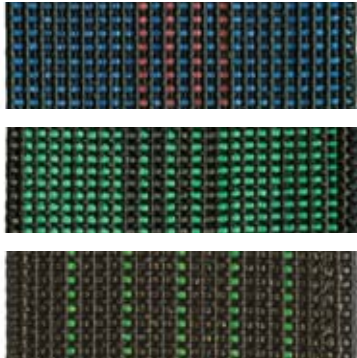

Colour	Grade	Width	Part #
Blue	2 (backing)	50mm	01ELA 50 B2
	3 (domestic)	50mm	01ELA 50 B3
	4 (commercial)	70mm	01ELA 70 B4
Green	4 (commercial)	50mm	01ELA 50 G4
	4 (commercial)	70mm	01ELA 70 G4
Black	5 (heavy duty)	50mm	01ELA TOP 5

SEW-IN STRETCH ELASTIC



Colour	Width	Length	Part #
Black	25mm	50m	01ELA 25 BLA
White	25mm	50m	01ELA 25 WHI
Black	12mm	100m	01ELA 12 BLA
White	12mm	100m	01ELA 12 WHI

JUTE WEBBING



Width	Roll Length	Part #
50mm	50m	01WEB JUT

MATTRESS BINDING TAPE



Colour	Cream	Sky Blue	Royal Blue	White	Black
Part #	19PUD TAP MAT CRE	19PUD TAP MAT SKY	19PUD TAP MAT ROY	19PUD TAP MAT WHI	19PUD TAP MAT BLA

Details Width: 36mm. Roll Length: 150m.

POLYPROPYLENE STRAPPING

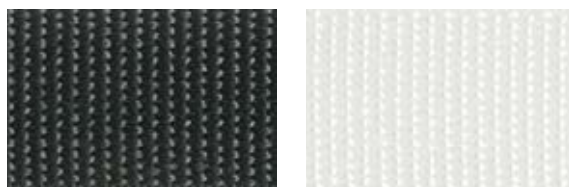

Colour	Black	White
Details	General purpose non-stretch strapping, eg bags, swags etc. Available in 50m rolls.	

Width	Colour	Part #
19mm	Black	19WEB PP 19 BLA
25mm	Black	19WEB PP 25 BLA
25mm	White	19WEB PP 25 WHI
38mm	Black	19WEB PP 38 BLA
38mm	White	19WEB PP 38 WHI
50mm	Black	19WEB PP 50 BLA
75mm	Black	19WEB PP 75 BLA

PRODUCT DETAILS

CARDBOARD & TRIM BOARD

PANEL BOARD – Sheets used for patterning and foundation.



Composition	Thickness	Sheet Size	Part #
Cardboard	1.0mm	1520 x 1020mm	01PUD PAN 1.0
	1.5mm	1520 x 1020mm	01PUD PAN 1.5
	1.5mm	760 x 1020mm	01UDA 10327
Masonite	2.5mm	1830 x 1220mm	01MAS 2.5
Rigid PVC	3.0mm	2440 x 1220mm	01 FOA BOA 3MM

TACKING STRIPS – Cardboard strips used to hide stapling. Sold by the kilo.



Thickness	Width	Length	Part #
1.2mm	13mm	910mm	01PUD TAC 13
1.5mm	15mm	1020mm	01SUD TAC
2.0mm	45mm	910mm	01PUD TAC 45

Nolan.UDA HOOK & LOOP FASTENERS

Product	Width	Type	Colour	Roll Length	Part #
 <p>Touch Fast A standard hook & loop fastening system.</p>	25mm	Hook	Black	25m	19TCH FST 25 BLA HOO
	25mm	Loop	Black	25m	19TCH FST 25 BLA LOO
	25mm	Hook	White	25m	19TCH FST 25 WHI HOO
	25mm	Loop	White	25m	19TCH FST 25 WHI LOO
	50mm	Hook	Black	25m	19TCH FST 50 BLA HOO
	50mm	Loop	Black	25m	19TCH FST 50 BLA LOO
	50mm	Hook	White	25m	19TCH FST 50 WHI HOO
	50mm	Loop	White	25m	19TCH FST 50 WHI LOO
 <p>Touch Press A standard hook & loop fastening system with a self adhesive backing.</p>	25mm	Hook	Black	25m	19TCH PRS 25 BLA HOO
	25mm	Loop	Black	25m	19TCH PRS 25 BLA LOO
	25mm	Hook	White	25m	19TCH PRS 25 WHI HOO
	25mm	Loop	White	25m	19TCH PRS 25 WHI LOO
	50mm	Hook	Black	25m	19TCH PRS 50 BLA HOO
	50mm	Loop	Black	25m	19TCH PRS 50 BLA LOO
	50mm	Hook	White	25m	19TCH PRS 50 WHI HOO
	50mm	Loop	White	25m	19TCH PRS 50 WHI LOO

PRODUCT DETAILS

VELCRO® BRAND FASTENING SYSTEMS

Product	Width	Type	Colour	Roll Length	Part #
 <p>SEW-ON A high quality hook and loop fastening system.</p>	25mm	Hook	Black	25m	19 VEL 10702
	25mm	Loop	Black	25m	19 VEL 10802
	25mm	Hook	White	25m	19 VEL 10706
	25mm	Loop	White	25m	19 VEL 10806
	50mm	Hook	Black	25m	19 VEL 11002
	50mm	Loop	Black	25m	19 VEL 11102
	50mm	Hook	White	25m	19 VEL 11006
	50mm	Loop	White	25m	19 VEL 11106
 <p>Pressure Sensitive A hook and loop fastener with a high bond strength, self adhesive backing.</p>	25mm	Hook	Black	25m	19 VEL 14747
	25mm	Loop	Black	25m	19 VEL 14847
	25mm	Hook	White	25m	19 VEL 14748
	25mm	Loop	White	25m	19 VEL 14848
	50mm	Hook	Black	25m	19 VEL 15008
	50mm	Loop	Black	25m	19 VEL 15135
	50mm	Hook	White	25m	19 VEL 15009
	50mm	Loop	White	25m	19 VEL 15109
 <p>One Wrap® A back-to-back hook and loop fastening system.</p>	12mm	One-Wrap	Black	22.8m	19 VEL 189755
	12mm	One-Wrap	White	22.8m	19 VEL 170015
	25mm	One-Wrap	Black	22.8m	19 VEL 189590
	25mm	One-Wrap	White	22.8m	19 VEL 189695
	50mm	One-Wrap	Black	22.8m	19 VEL 189661
	50mm	One-Wrap	White	22.8m	19 VEL 189699
 <p>Moulded A high strength hook fastener for semi permanent applications.</p>	Pressure sensitive (with 0172 self adhesive backing)				
	25mm	Hook	Black	20m	19 VEL 20019
	Sew-on				
	25mm	Hook	Black	20m	19 VEL 20020

Other colours, widths and VELCRO® Brand fastening systems are available on request.

USER GUIDE

Spiral Zippers & Slides

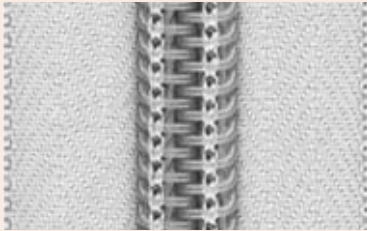

"SPIRAL TOOTH"
(Ziplon®) suited to curved shapes.



CHAIN WIDTH

Chain width is sometimes referred to in the trade as "number", eg "No.5" would be a Ziplon® of 5mm width.



SINGLE TAB
Operates from front only.

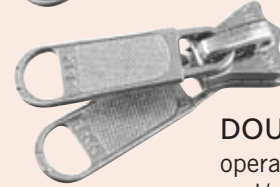

DOUBLE TAB
operates from front and/or rear.

PRODUCT DETAILS

ZIPPERS

YKK Continuous SPIRAL Chain & Slides

Product	Size	Colour/Finish	Length/Qty	Part #
Spiral Chain	#5	White	100m	19YKK CFZ 05 501
Spiral Chain	#5	Beige	100m	19YKK CFZ 05 573
Spiral Chain	#5	Black	100m	19YKK CFZ 05 580
Spiral Slide Single Tab	#5	Plastic	Box 100	19YKK CFS 05 SPN
Spiral Slide Single Tab	#5	Nickel	Box 100	19YKK CFS 05 SMN NIC
Spiral Slide Single Tab (Lock)	#5	Nickel	Box 100	19YKK CFS 05 SMP NIC
Spiral Slide Single Tab	#5	White	Box 100	19YKK CFS 05 SMP 501
Spiral Slide Single Tab	#5	Black	Box 100	19YKK CFS 05 SMP 580
Spiral Chain	#3	White	200m	19YKK CFZ 03 501
Spiral Chain	#3	Beige	200m	19YKK CFZ 03 573
Spiral Chain	#3	Black	200m	19YKK CFZ 03 580
Spiral Slide Type G	#3	Bronze	Box 100	19YKK CFS 03 SMP BRO
Spiral Slide Single Tab	#3	White	Box 100	19YKK CFS 03 SMA 501
Spiral Slide Single Tab	#3	Beige	Box 100	19YKK CFS 03 SMA 573
Spiral Slide Single Tab	#3	Black	Box 100	19YKK CFS 03 SMA 580

Nolan.UDA Continuous SPIRAL Chain & Slides

Spiral Chain	#4	Beige	100m	19ZIP NOL ZIP 04 BEI
Spiral Chain	#4	Black	100m	19ZIP NOL ZIP 04 BLA
Spiral Pinlock Slide Single Tab	#4	Beige Enamel	Box 200	19ZIP NOL SLI 04 BEI
Spiral Pinlock Slide Single Tab	#4	Black Enamel	Box 200	19ZIP NOL SLI 04 BLA

PRODUCT DETAILS

UPHOLSTERY BUTTONS

IMPORTANT NOTE: Astor and JDW are different brands.
Parts, dies and moulds are not interchangeable.

Range	Product	Size	Box Qty	Part #
JDW	Tops	30	2,000	01BUT 30 TOP ALL
		36	2,000	01BUT 36 TOP ALL
		45	1,000	01BUT 45 TOP ALL
JDW	Bottoms	30	2,000	01BUT 30 LOO
		36	2,000	01BUT 36 LOO
		45	1,000	01BUT 45 LOO
ASTOR		Refer size chart	1,000 except 44 line (500)	01BUT PDR (size) eg 01BUT PDR 28



P. D. R. upholstery wire loop

JDW ASTOR

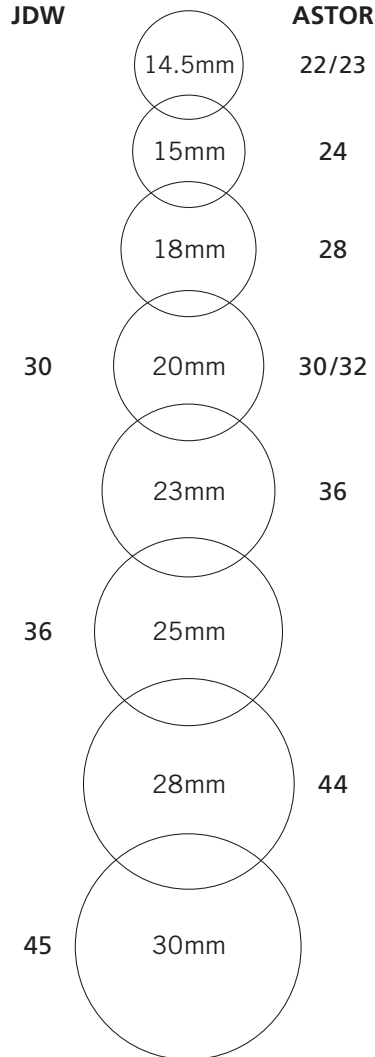

SIDE LEVER BUTTONING PRESS

Product

Part # 01BUT MAC2



JDW BUTTON CUTTER

Size 30: 01BUT 30 CUT
Size 36: 01BUT 36 CUT
Size 45: 01BUT 45 CUT



JDW BUTTON DIES

Size 30: 01BUT 30 DIE
Size 36: 01BUT 36 DIE
Size 45: 01BUT 45 DIE

ASTOR Button Cutter & Button Die also available on request.



ASTOR 51 BUTTON COVERING MACHINE

Product

Part # 01 MAC A51

Details 200 buttons/hour. Solid brass and cast alloy construction. Also doubles as a cutting press.



POLYPOPIN TUFTS & WASHERS

Item	Colour	Size	Part #
Tuft	Black	125mm	01TUF 125 BLA
	White	125mm	01TUF 125 WHI
	White	150mm	01TUF 150 WHI
Washers	Black	-	01WAS BLA
	White	-	01WAS WHI

Suited for futons. Sold in boxes of 100.



PRODUCT DETAILS

FINISHING STRIPS

SCROLL GIMP – Decorative trim for seat backs and cushions.

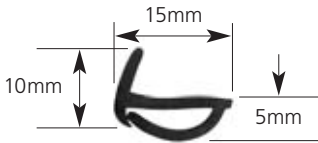
Colour	 Natural	 Shell	 Pink Dawn	 Oyster	 Dawn
Part #	01GIM NAT	01GIM SHE	01GIM PIN	01GIM OYS	01GIM DAW
Colour	 Cream	 Gold	 Burnt Toast	 Camel	 Maroon
Part #	01GIM CRE	01GIM GOL	01GIM BUR	01GIM CAM	01GIM MAR
Colour	 Wine	 Hunter Green	 Sea Mist	 Black	 Light Rose
Part #	01GIM WIN	01GIM HUN	01GIM SEA	01GIM BLA	01GIM LT ROS

Product	 BRAIDED COTTON PIPING	 HOLLOW PLASTIC PIPING	 SEAT EDGEMOULD PIPING
Part #	Size #3 (4mm): 01PIP COT 3 Size #4 (5mm): 01PIP COT 4 Size #5 (6mm): 01PIP COT 5 Size #7 (8mm): 01PIP COT 7 Size #9 (10mm): 01PIP COT 9	Black 3mm: 01PIP HOL 3 STD BLA White 3mm: 01PIP HOL 3 SOF WHI Black 4mm: 01PIP HOL 4 SOF BLA White 4mm: 01PIP HOL 4 SOF WHI	01SUD PIP EDG 
Details	Roll lengths: #3 400m. #4 600m. #5 400m. #7 250m. #9 150m.	Available in Black or White in 3mm x 1000m rolls and 4mm x 750m rolls.	For covering edges of plastic chairs, with flap designed to hide staples. 100m rolls.

Product	 'P' PIPING	 TRIMFLEX
Part #	12mm diameter: 01EDG 12 19mm diameter: 01EDG 19 25mm diameter: 01EDG 25	3/4 inch diameter (90m rolls): 01TRI 19 1 inch diameter (150m rolls): 01TRI 25
Details	Hollow PVC piping for seat edging. 100m rolls.	Expanded PU hollow section used for edging.

PRODUCT DETAILS

THREADS

SUNGUARD – UV stabilised bonded polyester. Matches Sunbrella colours.

B138					
	Black	Burgundy	Cadet Grey	Captain Navy	Natural
Part #	19 THRB138 BLA	19 THRB138 BUR	19 THRB138 CAD	19 THRB138 CAP	19 THRB138 NAT
B207			B207		
	Pacific Blue	Toast		Black	Natural
Part #	19 THRB138 PAC	19 THRB138 TOA	Part #	19 THRB207 BLA	19 THR B207 NAT

COATS DABOND

100% UV stabilised bonded polyester. Exceptional bond adhesion.

V138					
	Black	Green	Yellow	Blue	Beige
Part #	19 THR138 BLA	19 THR138 H11	19 THR138 H13	19 THR138 H16	19 THR138 H1719
Colour					
	Blue	Brown	Green	Red	Grey
Part #	19 THR138 H260	19 THR138 H27	19 THR138 H2737	19 THR138 H28	19 THR138 H5
Colour					
	Turquoise	Blue	Drab	Tan	Beige
Part #	19 THR138 H593	19 THR138 H609	19 THR138 H672	19 THR138 H6883	19 THR138 H838
Colour					
	Granite	Grey	Maroon	Natural	
Part #	19 THR138 M1853	19 THR138 M4331	19 THR138 M483	19 THR138 NAT	

USER GUIDE

The manufacturer of V138 does not warrant against dye transfer.

Size Conversion:	Number	Metric Size
	138	M20
	207	M12
	277	M10

V207

V277

Colour

Part # V207

Part # V277

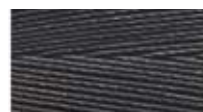

Black



Natural

19 THR 207 BLA

19 THR 277 BLA

19 THR 207 NAT

19 THR 277 NAT

PRODUCT DETAILS



COATS POLYFIL THREAD – Poly/cotton Blend

Specifications			Colour Availability					
Size	Thread Length	Part # *add Colour Code.	Colour Code	20	25	Size 36	50	120
20	1800m	19POL 20*	BLA	✓	✓	✓	✓	
25	2250m	19POL 25*	NAT	✓	✓	✓		✓
36	3250m	19POL 36*	WHI	✓	✓	✓	✓	
50	4000m	19POL 50*	47	✓	✓	✓		
120	5000m	19THR 120*	1023	✓	✓	✓		
Colour Range & Codes			2199	✓	✓	✓		
 <p>BLA NAT WHI</p> <p>3871 9256 6887</p> <p>8225 7639 47</p> <p>7841 2199 6426</p> <p>2990 6715 9271</p> <p>8275 7927 9526</p> <p>9927 1023 9952 7571</p>			2990	✓	✓	✓		
			3871			✓		
			6426			✓		
			6715	✓	✓	✓		
			6887	✓	✓	✓		
			7571	✓	✓	✓		
			7639		✓	✓		
			7841	✓	✓	✓		
			7927		✓	✓		
			8225	✓	✓	✓		
			8275		✓	✓		
			9256	✓		✓		
			9271	✓	✓	✓		
			9526	✓	✓	✓		
			9927	✓	✓			
			9952	✓	✓	✓		

		TWINE	
Product	 <p>DRIMA OVERLOCKING THREAD</p>	 <p>POLY LASHING TWINE</p>	 <p>NYLOTIE BUTTON TWINE</p>
Part #	White: 19THR DRI 40/2 WHI Black: 19THR DRI 40/2 BLA	01TWI LAS	(1): 01TWI NYO (2): 19THR TWI 250
Details	Available in White or Black. 10,000 metre spool. Used for edging fabric.	White only. Sold per roll. General tie down twine.	White only. (1): Sold by the kilo, 2 x rolls per kilo. (2): Sold by the 250grm roll. Used to tie upholstery buttons.

PRODUCT DETAILS

COATS TERKO THREAD – Poly/cotton Blend

Specifications			Colour Availability				
Size	Thread Length	Part # *add Colour Code.	Colour Code	Size			
				12	20	25	36
12	2500m	19THR 12*	BLA	✓	✓	✓	✓
20	2500m	19THR 20*	NAT	✓	✓	✓	✓
25	2500m	19THR 25*	WHI	✓	✓		✓
36	2500m	19THR 36*	H0003	✓			✓
Colour Range & Codes			H0004		✓	✓	✓
			H0012	✓	✓		
BLA	NAT	WHI	H0016		✓	✓	
			H0027	✓	✓	✓	✓
R3885	H16	H1778	H0519	✓	✓		
			H0673	✓	✓	✓	✓
H0519	H1080	H0012	H1080	✓	✓		
			H1778	✓			✓
H0673	R8243	H0027	R3885	✓	✓	✓	✓
			R8243			✓	✓
H0003	H0004		Technical Guide to Thread Weights DENIER is grams /9,000 metres TEX is grams /1,000 metres D'TEX is grams /10,000 metres				

	MARKERS		
Product	 CHINAGRAPH PENCILS	 TAILOR'S CHALK SINGLE COLOURS	 TAILOR'S CHALK MIXED BOX
Details	Soft pencils for marking fabric and vinyl. 10 per box.	50 per box.	5 colour mixed box available. includes red. 50 per box.
Colour/ Part #	Black: 01MAR CHI BLA White: 01MAR CHI WHI Yellow: 01MAR CHI YEL Blue: 01MAR CHI BLU	Black: 01MAR CHA BLA Blue: 01MAR CHA BLU White: 01MAR CHA WHI Yellow: 01MAR CHA YEL Powder: 01MAR CHA POW	01MAR CHA ASS

For more information on the full range of Nolan.UDA products, visit our website on: www.NolanUDA.com.au









PRODUCT DETAILS

UPHOLSTERY TOOLS

<p>Product</p>	 <p>BASIC KNIFE & BLADES</p>	 <p>HEAT CUTTER & BLADE</p> <p><i>Blade sold separately</i></p>
<p>Part #</p>	<p>Knife: 17KNI BAS Tube of 10 Blades: 17KNI BLA 201.4</p>	<p>Cutter: 17HOT KNI HSG-0 Blade: 17HOT TIP 100R</p>
<p>Product</p>	 <p>WISS INDUSTRIAL SHEARS</p>	 <p>SERRASHARP SCISSORS</p>
<p>Part #</p>	<p>25cm (10 inch): 17SCI WIS 20W 30cm (12 inch): 17SCI WIS 22W 25cm (10 inch) Left Handed: 17SCI WIS 20LH</p>	<p>20cm (8 inch): 17SCI SER 20 20cm (8 inch) Left Handed: 17SCI SER 20LH</p>
<p>Product</p>	 <p>MUNDIAL SCISSORS</p>	 <p>KRETZER SCISSORS</p>
<p>Part #</p>	<p>25cm (10 inch): 17SCI MUN 25 30cm (12 inch): 17SCI MUN 30</p>	<p>25cm (10 inch): 17SCI KRE 25</p>
<p>Product</p>	 <p>BLACK PANTHER SCISSORS</p>	 <p>MINI SNIPS</p>
<p>Part #</p>	<p>17SCI BLA 30</p>	<p>17SCI MIN SNI</p>
<p>Product</p>	 <p>TUFTING NEEDLE</p>	 <p>SKEWERS (Carpet Pins)</p>
<p>Part #</p>	<p>17OSB 417</p>	<p>01 NEE SKE 7</p>
<p>Details</p>		<p>Length: 75mm. Nickel plated. box of 100.</p>

PRODUCT DETAILS

UPHOLSTERY TOOLS (continued)

<p>Product</p>	 <p>AIR STAPLE GUN</p>	 <p>WEBBING STRETCHER</p>	 <p>WEBBING PLIERS</p>
<p>Part #</p>	<p>17 OSB TT 80/16</p>	<p>17OSB 255</p>	<p>17OSB 155</p>
<p>Product</p>	 <p>Straight Horizontal Bend Vertical Bend</p> <p>HOG RING PLIERS</p>		 <p>MUNDIAL LONG NOSE PLIERS</p>
<p>Part #</p>	<p>Straight: 17OSB 1440AC Vertical Bend: 17OSB 1440BC Horizontal Bend: 17OSB 1440CC</p>		<p>17MUN 438</p>
<p>Product</p>	 <p>TUCKING TOOL</p>	 <p>TACK & STAPLE REMOVER</p>	 <p>STAPLE LIFTER</p>
<p>Part #</p>	<p>17OSB 746</p>	<p>17OSB 121</p>	<p>17OSB 120.5</p>
<p>Product</p>	 <p>MAGNETIC TACK HAMMER</p>	 <p>RIPPER HAMMER</p>	 <p>Replacement cutters available.</p> <p>REVOLVING LEATHER PUNCH</p>
<p>Part #</p>	<p>17OSB 222</p>	<p>17OSB 277.5</p>	<p>Punch: 17OSB 155 Dies: 17OSB 155 DIE</p>

PRODUCT DETAILS

UPHOLSTERY NAILS

				
Finish	Antique	Black Enamel	Brass	Bronze Renaissance
Part #	01STU ANT*	01STU BLA*	01STU BRA*	01STU BRO*
				
Finish	Old Gold Speckle	Nickel	Oxford Hammered	White Enamel
Part #	01STU GOL*	01STU NIC*	01STU OXF*	01STU WHI*

*When specifying part numbers please add the Head Size, eg: 01STU ANT 10.5

SPECIFICATIONS & AVAILABILITY

Shank Size	13mm				16mm	19mm
Head Size	9.5mm	10.5mm	11mm	12.5mm	19mm	6mm
ANTIQUÉ		YES	YES		YES	
BLACK ENAMEL				YES		
BRASS		YES	YES			
BRONZE RENNAISSANCE	YES		YES			
OLD GOLD SPECKLE	YES	YES			YES	
NICKEL			YES		YES	YES
OXFORD HAMMERED			YES			
WHITE ENAMEL				YES		
Bag Quantities	1,000 except for Oxford Hammered (500)				250	1,000

Product	 INNOXA STRIPS
Part #	Bronze (16mm): 01 INO 160 BRO Bronze (10mm): 01 INO 100 BRO Nickel (16mm): 01 INO 160 NIC Nickel (10mm): 01 INO 100 NIC
Details	Available in Bronze Renaissance and Nickel. Box quantity 250. Matching nails included.

'KLINCH IT'
Tools and fasteners available on indent.
Fasteners in boxes of 5,000.
Part # 170SB 720

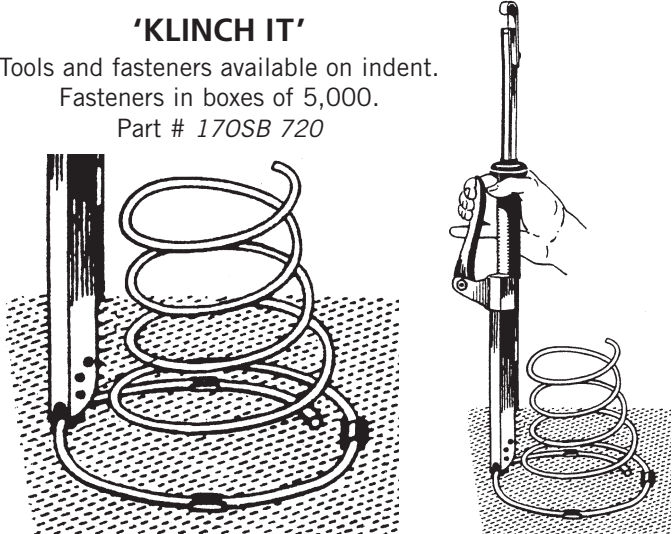

USER GUIDE

Adhesives

Adhesives and related solvents are widely and safely used in upholstery, trimming and carpet laying. However, these can be classified as 'hazardous' according to the criteria of the National Occupational Health & Safety Commission (NOHSC) of Australia. It is therefore essential that any risk associated with the use of these functional products is minimised by religiously following the instructions for use, storage and disposal that are printed on every container. In summary, the key points to remember are:-

- Avoid inhalation of fumes, and direct contact of glue with skin and eyes.
- Use only in a well ventilated space; having first eliminated any potential source of ignition.
- Store in a cool, fire isolated space; and dispose of empty containers in accordance with the law and environmental sensitivity.

PRODUCT DETAILS

CONTACT ADHESIVES

				
Product	3M FOAM FAST	3M HI TACK	3M MULTI PURPOSE	3M HIGH STRENGTH
Part #	12ADH AER 3M 74	12ADH AER 3M 76	12ADH AER 3M 77	12ADH AER 3M 90
Details	For bonding foam to foam or other substrate except PVC.	Multi-purpose, quick acting, high temperature resistant.	Quick acting, suited for bonding lightweight materials.	High strength, fast drying suited for polyethylene and polypropylene.
				
Product	3M GENERAL TRIM	3M NEOPRENE	STARSTUK PRESSURE SENSITIVE	STARSTUK CONTACT
Part #	12ADH AER 3M 8088	12ADH AER 3M 80	12ADH AER PB 924	12ADH AER PB 925
Details	Low VOC, clear high strength. Suited for carpet, jute, fabric and most plastics.	Suited for rubber and supported vinyls.	Hi-tack, suited for horizontal inverted surfaces. Suited for fabric and most plastics.	General purpose. Suited for fabric, foam & upholstery and most plastics.







PRODUCT DETAILS

GENERAL ADHESIVES

<p>Product</p>	 <p>NOLAN UDA CONTACT ADHESIVE</p>	 <p>BOSTIK CONTACT BOND</p>	 <p>BOSTIK 616 CONTACT ADHESIVE</p>
<p>Part #</p>	<p>Clear: 12ADH CON NOL 020C Red: 12ADH CON NOL 020R</p>	<p>1 litre: 12ADH CON BOS 1 4 litre: 12ADH CON BOS 4</p>	<p>12ADH CON 616 020</p>
<p>Details</p>	<p>Sprayable contact adhesive. 20 litre drums. Heat resistant. (also available in 200 litre drums)</p>	<p>Brushable contact adhesive. Available in 1 & 4 litre tins.</p>	<p>Sprayable, rapid dry with excellent green strength suited to furniture, upholstery & foam.</p>
<p>Product</p>	 <p>STARSTUK 925</p>	 <p>ANCHORWELD 1830</p>	 <p>HYBOND PVA GLUE</p>
<p>Part #</p>	<p>Cylinder: 12ADH CON PB925N Gun & Hose: 17ADH SPH</p>	<p>20 litre: 12ADH CON 1830 020 200 litre: 12ADH CON 1830 200</p>	<p>5 litre: 12ADH PVA HYB 05 20 litre: 12ADH PVA HYB 20</p>
<p>Details</p>	<p>Solvent free sprayable contact adhesive. Non flammable. 17.2kg cylinder and spray gun sold together or separately.</p>	<p>Styrene safe glue. Available in 20 & 200 litre tins.</p>	<p>General purpose PVA wood glue. Designed to be used with other fasteners. 5 & 20 litre drums.</p>
<p>Product</p>	 <p>BONDMASTER PVC GLUE</p>	 <p>TG4 HOT MELT GUN</p>	 <p>BOSTIK HOT MELT GLUE</p>
<p>Part #</p>	<p>1 litre: 12ADH PVC BON 01 10 litre: 12ADH PVC BON 10</p>	<p>12ADH HOT TG4</p>	<p>Clear: 12ADH HOT 6330 Yellow: 12ADH HOT 6303</p>
<p>Details</p>	<p>Effectively “welds” PVC. Melts two plastic surfaces into one another. 1 & 10 litre drums.</p>	<p>Electric powered, premium quality. Use in conjunction with hot melt glue sticks.</p>	<p>Available in clear (2.5kg), or yellow (1kg).</p>

PRODUCT DETAILS

SOLVENTS, CLEANERS & LUBRICANTS

Product	 BOSTIK 9913 UNIVERSAL SOLVENT	 BOSTIK 9907 PVC SOLVENT	 PLEXUS CLEAR PVC CLEANER
Part #	12SOL 9913 20	12SOL 9907 20	198g: 12CLE PLE 198 368g: 12CLE PLE 368
Details	Available in 20 litre drums. Used for de-greasing metal and rubber; equipment clean up.	Available in 20 litre drums. Can be used as a thinner and for cleaning.	CFC free spray. 198g & 368g cans. Boxes of 12. Proven product for cleaning clear PVC.
Product	 SILICONE LUBRICANT	 NON-SILICONE LUBRICANT	 CASTROL SEWING MACHINE OIL
Part #	12LUB SLI SIL	12LUB SLI NON	125ml: 12LUB OIL 125 1 litre: 12LUB OIL 1000
Details	Lubricant for trimming and upholstery. Available in silicone and non silicone formulations. NOTE: Silicone should not be used in a workshop that has high frequency welding equipment.		Available in 125ml & 1 litre bottles. Also used in general lube applications.

Details of Leather, Fasteners Fittings & Accessories, Upholstery Vinyl, and Hospital Mattress Ticking can be found in volumes 2, 3 & 4 of our catalogue, or on our website: www.NolanUDA.com.au

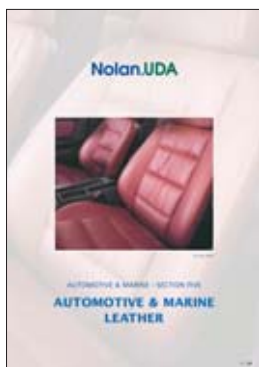

Volume 2, Section 5

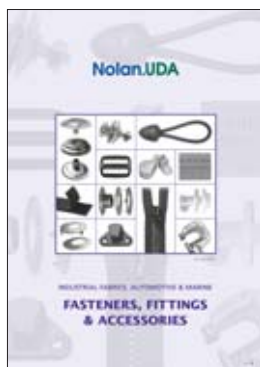

Volume 3

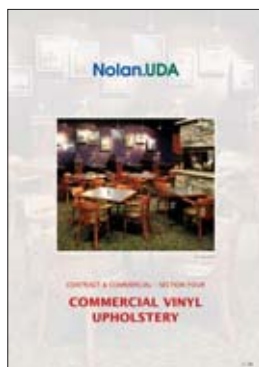

Volume 4, Section 4



Volume 4, Section 6

UPHOLSTERY FABRICS AND SUPPLIES – CATALOGUE INDEX

PRODUCT	Volume	page
3M Adhesive	V5.28	
Adhesives	V5.28	
Anchorweld	V5.29	
Astor Buttons	V5.20	
B138 Thread	V5.22	
B207 Thread	V5.22	
Base Cover	V5.9	
Binding Tape	V5.16	
Black Panther Scissors	V5.25	
Bostik Adhesive	V5.29	
Braided Cotton Piping	V5.21	
Button (Durable Fastener)	V5.15	
Button Covering Machine	V5.20	
Button Cutters and Dyes	V5.20	
Button Twine	V5.23	
Buttoning Machines	V5.20	
Buttoning Press	V5.20	
Buttons (Upholstery)	V5.20	
Calico	V5.8	
Caliquilt	V5.8	
Capri Upholstery Vinyl	V5.6	
Cerex Backed Foam	V5.11	
Chinagraph Pencils	V5.24	
Christmas Tree Clips	V5.13	
Cleaners	V5.30	
Coated Woven Polyethylene	V5.9	
Coats Thread	V5.23	
Coil Springs	V5.14	
Composition Ticking	V5.9	
Contact Adhesives	V5.28	
Cordova Upholstery Vinyl	V5.6	
Cotton Padding	V5.10	
Coverweave	V5.9	
Curved Needles	V5.13	
Cushion Foam	V5.11	
Cushion Inserts	V5.9	
Dabond Thread	V5.22	
Dacron (equivalent)	V5.10	
Drima Overlocking Thread	V5.23	
Durable Fasteners	V5.15	
Dust Cover	V5.9	
Econoquilt	V5.8	
Edge Moulding	V5.21	
Elastic Webbing	V5.16	
Eyelet (Durable Fastener)	V5.15	
Fabrics	V5.5	
Finishing Strips	V5.21	
Foam	V5.11	
Gimp	V5.21	
Grey Needled Wadding	V5.10	
Heat Cutter	V5.25	
Herringbone Twill	V5.8	
Hessian Rolls	V5.10	
Hessian Webbing	V5.16	
Hi-Load Foam	V5.12	
Hog Ring Fasteners	V5.13	
Hog Ring Pliers	V5.26	
Hollow Plastic Piping	V5.21	
Holt Melt Glue	V5.29	
Hook and Loop Tape	V5.17	
Hot Melt Gun	V5.29	
Innox Strips	V5.27	
JDW Buttons	V5.20	
Jute Webbing	V5.16	
Klinch-It	V5.27	
Knives and Blades	V5.25	
Kretza Scissors	V5.25	
Leather	V5.5	
Lintas	V5.10	
Loose Cotton Filling	V5.10	
Loose Polyester Filling	V5.10	
Lubricant	V5.30	
Magnetic Tack hammer	V5.26	
Markers	V5.24	
Mattress Binding Tape	V5.16	
Mattress Ticking	V5.9	
Mattress Ventilator	V5.13	
Mini Snips	V5.25	
Mini Tub Leg	V5.14	
Moulded Velcro	V5.18	
Mundial Pliers	V5.26	
Mundial Scissors	V5.25	
Nail Glide	V5.14	
Nail Strips	V5.27	
Nails (Upholstery)	V5.27	
Natural Calico	V5.8	
NovoFeltro	V5.9	
Nylex (now Vytex) Seating Vinyls	V5.6	
Nylotie	V5.23	
One Wrap Velcro	V5.18	
Overlocking Thread	V5.23	
Padding	V5.10	
Panel Board	V5.17	
PDR Buttons (Astor)	V5.20	
Piping	V5.21	
Pli-Grip	V5.13	
Polyfil Thread	V5.23	
Poly Lashing Twine	V5.23	
Polyester Thread	V5.22	
Polyester Wadding	V5.10	
Polypoppin Tufts and Washers	V5.20	
Polypropylene Strapping	V5.16	
Polyquilt	V5.8	
Polyurethane Foam	V5.11	
Premaquilt	V5.8	
Premium Underlay	V5.10	
Press Stud Fasteners	V5.15	
Pressure Sensitive Adhesive	V5.28	
Pressure Sensitive Velcro	V5.18	
PVA Glue	V5.29	
PVC Glue	V5.29	
Quilts	V5.8	
Re-Bonded Foam	V5.12	
Regulators	V5.13	
Revolving Leather Punch	V5.26	
Ripper Hammer	V5.26	
Roll Foam	V5.11	
Roto Glide	V5.14	
Scissors	V5.25	
Seat Edgemould Piping	V5.21	
Seat Edging	V5.21	
Seating Fabrics and Vinyls	V5.5	
Self Adhesive Felt	V5.14	
Serrasharp Scissors	V5.25	
Sew-on Velcro	V5.18	
Sewing machine Oil	V5.30	
Shark Trim	V5.13	
Shears	V5.25	
Sheet Foam	V5.11	
Silicone Spray	V5.30	
Skewers (Carpet Pins)	V5.25	
Slides (Zippers)	V5.19	
Socket (Durable Fastener)	V5.15	
Sofa Legs and Glides	V5.14	
Solvents	V5.30	
Spiral Chain Zippers	V5.19	
Spradling Upholstery Vinyl	V5.6	
Spray Adhesives	V5.28	
Spring Clips	V5.13	
Springs	V5.14	
Spun Bonded Calico	V5.9	
Staple Gun	V5.26	
Staple Lifter	V5.26	
Staples	V5.13	
StarStuk Adhesive	V5.28	
Strapping	V5.16	
Stretch Elastic	V5.16	
Stud (Durable Fastener)	V5.15	
Sunbrella Seating Fabrics	V5.5	
Sunguard Thread	V5.22	
SuperFlock	V5.10	
Supraquilt	V5.8	
Supratex	V5.9	
Synthetic Calico	V5.9	
Tack and Staple Remover	V5.26	
Tack Strip	V5.13	
Tacking Strips	V5.17	
Tailor's Chalk	V5.24	
Terko Thread	V5.24	
Thread	V5.22	
Tools (Durable Fasteners)	V5.15	
Tools (Upholstery)	V5.25	
Touch Fast	V5.17	
Touch Press	V5.17	
TrimFix	V5.13	
Trimflex	V5.21	
Tub Leg	V5.14	
Tucking Tool	V5.26	
Tufting Needle	V5.25	
Twine	V5.23	
Twist Pins	V5.13	
Underlay	V5.10	
Upholstery Buttons	V5.20	
Upholstery Fabric	V5.5	
Upholstery Nails	V5.27	
Upholstery Tools	V5.25	
Upholstery Vinyls	V5.6	
V138 Thread	V5.22	
V207 Thread	V5.22	
V277 Thread	V5.22	
Velcro	V5.18	
Vytex Fabrics	V5.6	
Wadding	V5.10	
Washers (Polypoppin)	V5.20	
Webbing Clips	V5.13	
Webbing Elastic	V5.16	
Webbing Jute	V5.16	
Webbing Pliers	V5.26	
Webbing Stretcher	V5.26	
Wiss Shears	V5.25	
YKK Zippers	V5.19	
Zig Zag Spring Clip	V5.13	
Zig Zag Springs	V5.14	
Zippers	V5.19	

Nolan.UDA

SYDNEY

3 Bradford Street, Alexandria, NSW 2015
Telephone: (02) 9669 3333
Fax: (02) 9669 3166

NEWCASTLE

66 Orlando Road, Lambton, NSW 2299
Telephone: (02) 4957 7766
Fax: (02) 4952 6737

BRISBANE

14 Lions Park Drive, Yatala, QLD 4207
Telephone: (07) 3387 8500
Fax: (07) 3807 8300

MELBOURNE

55 Cleeland Road, Oakleigh South, VIC 3167
Telephone: (03) 9545 5588
Fax: (03) 9545 5582

ADELAIDE

489 Cross Keys Road, Cavan, SA 5094
Telephone: (08) 8260 1055
Fax: (08) 8260 1655

PERTH

18 Hazelhurst Street, Kewdale, WA 6105
Telephone: (08) 9376 2666
Fax: (08) 9353 1215

DARWIN

Unit 1, 6 Finniss Street, Darwin, NT 0800
Telephone: (08) 8981 1555
Fax: (08) 8981 1533

info@nolans.com.au

www.NolanUDA.com.au