



FASTENERS, FITTINGS & ACCESSORIES

INDUSTRIAL FABRICS, AUTOMOTIVE & MARINE



E3 August 2008

Nolan Warehouses

Sydney: (02) 9669 3333 • Newcastle: (02) 4957 7766 • Brisbane: (07) 3808 1888
Melbourne: (03) 9545 5588 • Adelaide: (08) 8340 7979 • Perth: (08) 9328 4777





www.nolans.com.au

PRODUCT DETAILS

PRESS STUD DURABLE FASTENERS

BUTTON	Details	Finish/colour	Barrel Size	Box Quantity	Part #
	Use with durable socket <i>*Brass with plastic coated dome</i>	Nickel Plated Brass	3/16"	200 & 1000	03 DUR 636
			1/4"	200 & 1000	03 DUR 670
		Stainless Steel	1/4"	200 & 1000	03 DUR 582-1-13
		Black*	1/4"	200	03 DUR 670 PBLK
		Burgundy*	1/4"	200	03 DUR 670 PBUR
		Navy*	1/4"	200	03 DUR 670 PNVY
		White*	1/4"	200	03 DUR 670 PWHT
SOCKET	Details	Finish	Type	Box Quantity	Part #
	Use with durable button	Nickel Plated Brass	Easy Action	200 & 1000	03 DUR E548
			Common	200 & 1000	03 DUR C548
			Tight Action	200 & 1000	03 DUR T548
		Stainless Steel	Common	200 & 1000	03 DUR 582-1-3
			Tight Action	200 & 1000	03 DUR 582-1-5
STUD	Details	Finish		Box Quantity	Part #
	Use with durable eyelet	Nickel Plated	-	200 & 1000	03 DUR 550
		Brass Stainless Steel	-	200 & 1000	03 DUR 582-1-1
EYELET	Details	Finish	Barrel Size	Box Quantity	Part #
	Use with durable stud	Nickel Plated Brass	1/4"	200 & 1000	03 DUR 550A
			5/16"	200 & 1000	03 DUR 550C
		Stainless Steel	1/4"	200 & 1000	03 DUR 582-1-2
STUD	Details	Finish		Box Quantity	Part #
	Eyelet with 8 gauge drill point screw	Stainless Steel	-	100	03 DUR 705916

TOOLS









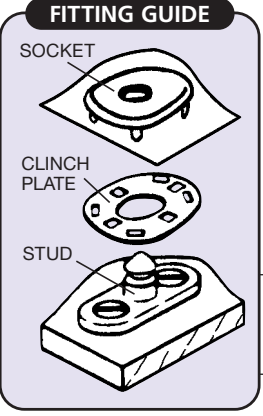

Product				FITTING GUIDE 
	Button Die	Stud Die	Bench Die Holder	
Part #	03 DIE 1401	03 DIE 1407	03 TOO 194	
Details	Use with 194 holder	Use with 194 holder	Use with 1401/1407	
Product				
	Socket/Stud Hand Tool			
	Part # 03 TOO 164			

PRODUCT DETAILS

SELF PIERCING EYELETS

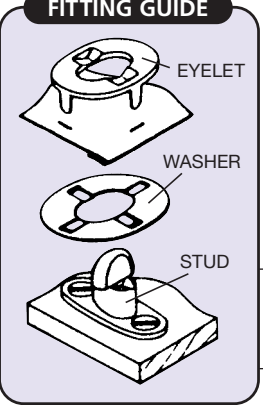

Size	Washer	Finish	Box Qty	Part #	Hand Tool
SP0 	Plain	Nickel	1,000	03 EYE SP0+A.100	 Part # 03 TOO 180
	Plain	Brass	1,000	03 EYE SP0+A.800	
SP1 	Plain	Nickel	1,000	03 EYE SP1+A.100	 Part # 03 TOO 181
	Plain	Brass	1,000	03 EYE SP1+A.800	
	Plain	Black	1,000	03 EYE SP1+A.824	
SP3 	Plain	Nickel	1,000	03 EYE SP3+A.100	 Part # 03 TOO 183
	Plain	Brass	1,000	03 EYE SP3+A.800	
	Plain	S/Steel	1,000	03 EYE SP3+A.316	
	Plain	Black	1,000	03 EYE SP3+A.824	
	Spur Tooth	Nickel	1,000	03 EYE SP3+AS.100	
	Spur Tooth	Brass	1,000	03 EYE SP3+AS.800	
	Spur Tooth	S/Steel	1,000	03 EYE SP3+AS.316	
	Spur Tooth	Black	1,000	03 EYE SP3+AS.824	
SP4 	Plain	Nickel	1,000	03 EYE SP4+A.100	 Part # 03 TOO 184
	Plain	Brass	1,000	03 EYE SP4+A.800	
	Plain	S/Steel	1,000	03 EYE SP4+A.316	
	Plain	Black	1,000	03 EYE SP4+A.824	
	Spur Tooth	Nickel	1,000	03 EYE SP4+AS.100	
	Spur Tooth	Brass	1,000	03 EYE SP4+AS.800	
	Spur Tooth	S/Steel	1,000	03 EYE SP4+AS.316	
	Spur Tooth	Black	1,000	03 EYE SP4+AS.824	
SP6 	Plain	Nickel	1,000	03 EYE SP6+A.100	 Part # 03 TOO 186
	Plain	Brass	1,000	03 EYE SP6+A.800	
	Plain	S/Steel	1,000	03 EYE SP6+A.316	
	Plain	Black	1,000	03 EYE SP6+A.824	
	Spur Tooth	Nickel	1,000	03 EYE SP6+AS.100	
	Spur Tooth	Brass	1,000	03 EYE SP6+AS.800	
	Spur Tooth	S/Steel	1,000	03 EYE SP6+AS.316	
	Spur Tooth	Black	1,000	03 EYE SP6+AS.824	
SP7 	Plain	Nickel	500	03 EYE SP7+A.100	 Part # 03 TOO 187
	Plain	Brass	500	03 EYE SP7+A.800	
	Plain	S/Steel	500	03 EYE SP7+A.316	
	Plain	Black	500	03 EYE SP7+A.824	
	Spur Tooth	Nickel	500	03 EYE SP7+AS.100	
	Spur Tooth	Brass	500	03 EYE SP7+AS.800	
	Spur Tooth	S/Steel	500	03 EYE SP7+AS.316	
	Spur Tooth	Black	500	03 EYE SP7+AS.824	
SP9 	Plain	Nickel	250	03 EYE SP9+A.100	 Part # 03 TOO 189
	Plain	Brass	250	03 EYE SP9+A.800	
	Plain	S/Steel	250	03 EYE SP9+A.316	
	Plain	Black	250	03 EYE SP9+A.824	
	Spur Tooth	Nickel	250	03 EYE SP9+AS.100	
	Spur Tooth	Brass	250	03 EYE SP9+AS.800	
	Spur Tooth	S/Steel	250	03 EYE SP9+AS.316	
	Spur Tooth	Black	250	03 EYE SP9+AS.824	

FASTENERS – PRODUCT DETAILS





LIFT THE DOT FASTENERS			
Product	 Socket & Clinch Plate	 Stud	 Stud
Part #	Regular: 03 LTD 608/708A Long: 03 LTD 609/708A	03 LTD 848	Single: 03 LTD 9523/8 Double: 03 LTD 9533/8
Finish	Nickel plated brass	Nickel plated brass	Nickel plated brass
Details	Use in conjunction with all LTD stud types	Use in conjunction with LTD Socket and Clinch Plate set	Hexagonal base. No. 8 self tapping steel screw 9mm (3/8"). Use in conjunction with LTD Socket and Clinch Plate set
FITTING GUIDE			
			
Product	 169B Hand Tool		 151 Hand Tool
Part #	03 TOO 169B		03 TOO 151
Details	Suits LTD Stud		Suits LTD Socket and Clinch Plate
COMMONSENSE TURN-BUTTON FASTENERS			
Product	 Eyelet with Washer	 Stud	 Stud with Clinch Plate
Part #	03 TUR 400/400A	Single: 03 TUR 401 Double: 03 TUR 402	Single: 03 TUR 410/410A Double: 03 TUR 412/410A
Finish	Nickel plated brass	Nickel plated brass	Nickel plated brass
Details	Use in conjunction with Turn Button Stud and Clinch Plate. Suits fixing to a flexible surface.	Suits mounting to a hard surface.	Use in conjunction with Turn Button Eyelet and Washer. Suits fixing to a flexible surface.
FITTING GUIDE			
			
Product	 450 Hand Tool		 171 Hand Tool
Part #	03 TOO 450		03 TOO 171
Details	Suits 400 Turn Button Eyelet and Washer		Suits 410/412 Turn Button Stud

FASTENERS – PRODUCT DETAILS

INDUSTRIAL FASTENERS

Product		
	ROPE SPLICE CLIPS	ROPE END CLIPS
Finish/Qty	Zinc/Box of 1000	Zinc/Box of 1000
Part #	6mm: <i>03 SPL 550-21-1.305</i>	6mm: <i>03 END 550-2-7</i>
	8mm: <i>03 SPL 550-21-2.305</i>	8mm: <i>03 END 550-2-8</i>
	10mm: <i>03 SPL 550-21-3.305</i>	

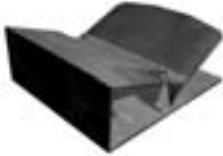

AUTOMOTIVE & MARINE FASTENERS

Product				
	SNAP SAC	TRIM FASTENER	EDGE CLIP	WINDSHIELD CLIPS
Part #	<i>03 CLI 613.1.6</i>	<i>03 CLI 49082</i>	<i>03 CLI 1622</i>	<i>3/4": 03 CLI XX10388</i> <i>7/8": 03 CLI XX10391</i>
Finish/Qty	Plastic/Box of 100	Zinc Plated/Box of 100	Carbon Steel/Box of 200	Zinc Plated/Box of 100

MISCELLANEOUS FASTENERS

Product			
	MAGI CLIP	PAINT TIN LID CLIP	MATTRESS VENTILATOR
Part #	<i>03CLI 550-13-92</i>	Easy action: <i>03 CLI E550-13-26</i> Tight action: <i>03 CLI T550-13-26</i>	Nickel: <i>03 VEN 590-9-19100</i> Brass: <i>03 VEN 590-9-19731</i>
Finish/Qty	Zinc Plated/Box of 2000	Zinc Plated/Box of 8000	Both supplied with ACE7 eyelet. Box of 2000

TENAX FASTENERS

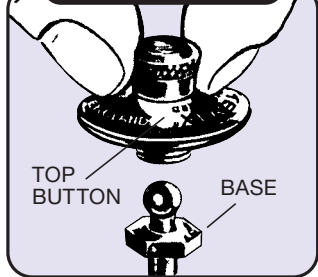
Part #			
	<i>10 TEN THR</i>	<i>10 TEN NUT</i>	
Finish	Nickel plated brass	Nickel plated brass	

FOOT PRESS TOOLS

PRODUCT DETAILS

H50/68 HEAVY DUTY FOOT PRESS AND STAND ASSEMBLY



Part # 03 MAC H50.H68

Refer to the table opposite for Chuck & Die requirements.

The chuck is the upper tool and the die is the lower tool.



HP 100 HAND PRESS

Part # 03 MAC HP100



PRESS STUD DURABLE DIES

Description of Fastener	Spindle Type	Chuck & Die Part #
670/636 Durable Button	Plain	03 DIE 1401
550A/550C Durable Stud	Plain	03 DIE 1407
548 Durable Socket	Plain	03 DIE 1410
550 Durable Eyelet	Plain	03 DIE 1412

EYELET & WASHER CHUCK & DIE

Description of Fastener	Spindle Type	Chuck & Die Part #
SPO Eyelet & Washer	Threaded	03 DIE 1611/1612
SP1 Eyelet & Washer	Threaded	03 DIE 1544/1545
SP3 Eyelet & Washer	Threaded	03 DIE 1532/1533
SP4 Eyelet & Washer	Threaded	03 DIE 1613/1614
SP6 Eyelet & Washer	Threaded	03 DIE 1542/1543
SP7 Eyelet & Washer	Threaded	03 DIE 1538/1539
SP9 Eyelet & Washer	Threaded	03 DIE 1615/1616

ROPE SPLICE CLIP CHUCK & DIE

Description of Fastener	Spindle Type	Chuck & Die Part #
6mm Rope Splice Clip	Plain	03 DIE 1261/1262
8mm Rope Splice Clip	Plain	03 DIE 1263/1264
10mm Rope Splice Clip	Plain	03 DIE 1265/1266











ROPE END CLIP CHUCK & DIE

Description of Fastener	Spindle Type	Chuck & Die Part #
6mm Rope End Clip	Plain	03 DIE 1241/1242
8mm Rope End Clip	Plain	03 DIE 1243/1244

LIFT THE DOT FASTENER CHUCK & DIE

Description of Fastener	Spindle Type	Chuck & Die Part #
608/708A Socket & Clinch Plate	Plain	03 DIE 1454/1455

TOOLS – PRODUCT DETAILS

<p>Product</p>	 <p>HOLE PUNCH</p>	 <p>WISS INDUSTRIAL SHEARS</p>		
<p>Part #</p>	<p>17 OSB 155</p>	<p>10 inch: 17 WIS 20W</p>	<p>12 inch: 17 WIS 22W</p>	
<p>Product</p>	 <p>ZIPPER STOP PLIERS</p>	 <p>HOG RING PLIERS</p>		
<p>Part #</p>	<p>17 OSB 1012</p>	<p>17 OSB 1440AC</p>		
<p>Product</p>	 <p>TUCKING TOOL</p>	 <p>STAPLE LIFTER</p>		
<p>Part #</p>	<p>17 OSB 746</p>	<p>17 OSB 120.5</p>		
<p>Product</p>	 <p>PRES-N-SNAP</p>	<p>DIES FOR PRES-N-SNAP</p> <div style="display: flex; justify-content: space-around;"> <div data-bbox="734 1512 933 1803">  <p>550/550A</p> </div> <div data-bbox="965 1512 1165 1803">  <p>670/C548</p> </div> <div data-bbox="1197 1512 1396 1803">  <p>SP4</p> </div> </div>		
<p>Part #</p>	<p>17 PNS TOOL</p>	<p>17 PNS 550/550A</p>	<p>17 PNS 670/C548</p>	<p>17 PNS SP4</p>
<p>Details</p>	<p>Comes complete with dies for press stud durables and SP4 eyelets.</p>	 <p>REPLACEMENT RUBBER RETAINING RING Fits 550/550A & 670/C548 Dies Part # 17 PNSM 2700</p>		

THREAD

PRODUCT DETAILS

SUNGUARD THREAD

UV stabilised bonded polyester. Matches Sunbrella colours.

B138					
	Colour	Black	Burgundy	Cadet Grey	Captain Navy
Part #	19 THRB138 BLA	19 THRB138 BUR	19 THRB138 CAD	19 THRB138 CAP	19 THRB138 NAT
B207			B207		
	Colour	Pacific Blue		Colour	Black
Part #	19 THRB138 PAC	19 THRB138 TOA	Part #	19 THRB207 BLA	19 THRB207 NAT

COATS DABOND THREAD

UV stabilised bonded polyester. Exceptional bond adhesion.

V138					
	Colour	Black	Green	Yellow	Blue
Part #	19 THR138 BLA	19 THR138 H11	19 THR138 H13	19 THR138 H16	19 THR138 H1719
V138					
	Colour	Blue	Brown	Green	Red
Part #	19 THR138 H260	19 THR138 H27	19 THR138 H2737	19 THR138 H28	19 THR138 H5
V138					
	Colour	Turquoise	Blue	Drab	Tan
Part #	19 THR138 H593	19 THR138 H609	19 THR138 H672	19 THR138 H6883	19 THR138 H838
V138					
	Colour	Granite	Grey	Maroon	Natural
Part #	19 THR138 M1853	19 THR138 M4331	19 THR138 M483	19 THR138 NAT	

NOTE: The manufacturer of V138 does not warrant against dye transfer.

Size Conversion Guide: 138 = metric size M20
207 = metric size M12

V207

Colour

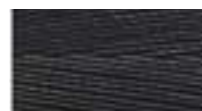

Black



Natural

Part #

19 THR207 BLA

19 THR207 NAT



WEBBINGS & TAPES

PRODUCT DETAILS

SHADESAIL WEBBING

Roll length: 100m Width: 50mm* Colour						
	Blue	Green	Beige	White	Grey	Black
Part #	19 WEBSHA BLU	19 WEBSHA GRE	19 WEBSHA BEI	19 WEBSHA WHI	19 WEBSHA GRY	19 WEBSHA BLA
*Black & White also available in 25mm width – Part # Black: 19 WEBSHA BLA 25 White: 19 WEBSHA WHI 25						

POLYPROPYLENE WEBBING

Roll length: 50m Width: 25mm (Black & White)			Roll length: 50m Width: 50mm (Black only)	
	Black	White		Black
Part #	19 WEBPP25 BLA	19 WEBPP25 WHI		19 WEBPP50 BLA

POLYESTER EDGE TAPE *(Caution: not suited for outdoor use)*

Roll length: 200m Width: 20mm & 25mm. Comes with centre fold line.				
	Black	Grey	Maroon	Beige
Part # (20mm width)	19 EDG20 BLA	19 EDG20 GRY	19 EDG20 MAR	19 EDG20 BEI
Part # (25mm width)	19 EDG25 BLA	–	–	–
Roll length: 200m Width: 20mm. Comes with centre fold line.				
	Navy	Blue	Heritage Green	White
Part # (20mm width)	19 EDG20 NAV	19 EDG20 BLU	19 EDG20 HER	19 EDG20 WHI

LOAD RESTRAINT WEBBING

Break strength: 4900kg



Part #

19 WEB50 LOA

Dimensions

Roll length: 50 metres. Width: 50mm

ELASTIC WEBBING

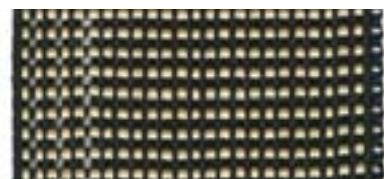

19 ELA51

Roll length: 100 metres. Width: 51mm

BINDINGS

PRODUCT DETAILS

SUNEDGE BINDING *(Recommended for outdoor use)*

Colour	 Black	 Burgundy	 Cadet Grey	 Captain Navy
Part #	04 CEN JET	04 CEN BUR	04 CEN CAD	04 CEN CAP
Colour	 Pacific Blue	 Toast	<p>SUNEDGE BINDING is a UV stabilised binding tape, designed to be used in conjunction with Sunbrella fabrics. It features a centre fold line for ease of fabrication and is an exact match with the standard Sunbrella colours.</p> <p>Width: 23mm. Roll Length: 183m (200 yards)</p>	
Part #	04 CEN PAC	04 CEN TOA		

ARDWYN PRE-FOLDED BIAS BINDING

Colour	 Black	 Dark Grey	 Light Grey	 White	 Almond
Part #	19BIA 300 BLA	19BIA 300 DAR GRY	19BIA 300 LIG GRY	19BIA 300 WHI	19BIA 300 ALM
Colour	 Red	 Maroon	 Dark Blue	 Royal Blue	
Part #	19BIA 300 RED	19BIA 300 MAR	19BIA 300 DAR BLU	19BIA 300 ROY BLU	

NOLAN PRE-FOLDED BIAS BINDING

Colour	 Black	 Blue	 Grey	 Red	 White
Part #	19 BIA BLA	19 BIA BLU	19 BIA GRY	19 BIA RED	19 BIA WHI

NOLAN PREMIUM BIAS BINDING

Colour	 Black	 White
Part #	19BIA PREM BLK	19BIA PREM WHI





DIMENSIONS FOR BIAS BINDINGS

Product	Width	Roll Length
Ardwyn Pre-Folded	30mm	45.8m
Nolan Pre-Folded	30mm	100m
Nolan Premium	30mm	100m

ZIPPERS

PRODUCT DETAILS





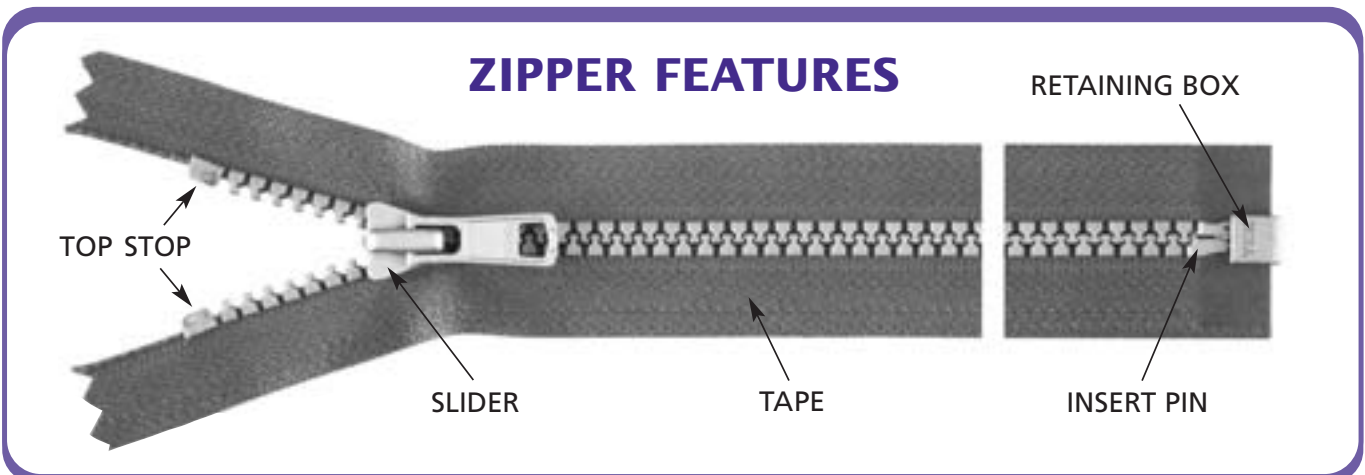

OPEN ENDED ZIPPERS

# 10 White Open Ended CHUNKY			# 10 Black Open Ended CHUNKY		
	Length	Part #		Length	Part #
	60cm	19YKK VF01050 W060		60cm	19YKK VF01050 B060
	104cm	19YKK VF01050 W104		104cm	19YKK VF01050 B104
	122cm	19YKK VF01050 W122		122cm	19YKK VF01050 B122
	153cm	19YKK VF01050 W153		153cm	19YKK VF01050 B153
	198cm	19YKK VF01050 W198		198cm	19YKK VF01050 B198
	244cm	19YKK VF01050 W244		244cm	19YKK VF01050 B244
	300cm	19YKK VF01050 W300		300cm	19YKK VF01050 B300
	400cm	19YKK VF01050 W400		400cm	19YKK VF01050 B400
	600cm	19YKK VF01050 W600		600cm	19YKK VF01050 B600
800cm	19YKK VF01050 W800	800cm	19YKK VF01050 B800		
# 8 White Open Ended CHUNKY			# 8 Black Open Ended CHUNKY		
	Length	Part #		Length	Part #
	122cm	19YKK VSOR 85DW2L W122		122cm	19YKK VSOR 85DW2L B122
	198cm	19YKK VSOR 85DW2L W198		198cm	19YKK VSOR 85DW2L B198
#8 Open Ended Zippers are compatible with US manufactured OE boats					
# 10 Open Ended SPIRAL					
	Product		Colour	Part #	
	Replacement Window Zipper – Jeep		Black	19YKK Z084250 580	
	Replacement Window Zipper – Vitara		Black	19YKK Z084183 580	



PRODUCT DETAILS

Continuous **CHUNKY** Chain & Slides

	Product	Size	Colour/Finish	Length/Qty	Part #
	Chunky Chain	#10	White	100m	19YKK VFCH10 501
	Chunky Chain	#10	Green	100m	19YKK VFCH10 566
	Chunky Chain	#10	Beige	100m	19YKK VFCH10 573
	Chunky Chain	#10	Black	100m	19YKK VFCH10 580
	Chunky Slide Single Tab	#10	White Enamel	Box 100	19YKK 10VFDA-E501
	Chunky Slide Single Tab	#10	Black Enamel	Box 100	19YKK 10VFDA-E580
	Chunky Slide Double Tab	#10	White Enamel	Box 100	19YKK 10VFDWWE501
	Chunky Slide Double Tab	#10	Black Enamel	Box 100	19YKK 10VFDWWE580
	Chunky Slide Single Tab	#10	Nickel	Box 100	19YKK 10VFDA-NIC
	Chunky Slide Double Tab	#10	Nickel	Box 100	19YKK 10VFDWW-NIC
	Chunky Slide Single Tab	#10	White Plastic	Box 100	19YKK 10VFTA-501
	Chunky Slide Single Tab	#10	Black Plastic	Box 100	19YKK 10VFTA-580
	Chunky Slide Double Tab	#10	White Plastic	Box 100	19YKK 10VFTW-501
	Chunky Slide Double Tab	#10	Black Plastic	Box 100	19YKK 10VFTW-580
	Chunky Chain	#5	White	200m	19YKK VFCH5 501
	Chunky Chain	#5	Black	200m	19YKK VFCH5 580
	Chunky Slide Single Tab	#5	White Enamel	Box 100	19YKK 5VFDA-E501
	Chunky Slide Single Tab	#5	Black Enamel	Box 100	19YKK 5VFDA-E580
	Chunky Slide Single Tab	#5	White Plastic	Box 100	19YKK 5VFTA-501
	Chunky Slide Single Tab	#5	Black Plastic	Box 100	19YKK 5VFTA-580
	Chunky Slide Double Tab	#5	White Enamel	Box 100	19YKK 5VFDWW-E501
	Chunky Slide Double Tab	#5	Black Enamel	Box 100	19YKK 5VFDWW-E580

CHUNKY TOOTH

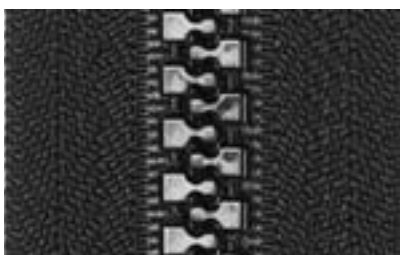

ZIPPER FEATURES



SINGLE TAB
operates from front only



DOUBLE TAB
operates from front and/or rear

PRODUCT DETAILS

Continuous SPIRAL Chain & Slides

	Product	Size	Colour/Finish	Length/Qty	Part #
	Spiral Chain	#10	White	100m	19YKK CFCH10 501
	Spiral Chain	#10	Green	100m	19YKK CFCH10 566
	Spiral Chain	#10	Beige	100m	19YKK CFCH10 573
	Spiral Chain	#10	Black	100m	19YKK CFCH10 580
	Weldable Spiral Chain	#10	White	100m	19YKK CFCH10 501W
	Spiral Slide Single Tab.	#10	Nickel	Box 100	19YKK CFDFL NIC
	Spiral Slide Double Tab.	#10	Nickel	Box 100	19YKK DW3L NIC
	Spiral Chain	#5	White	100m	19YKK CNCH5 501
	Spiral Chain	#5	Beige	100m	19YKK CNCH5 573
	Spiral Chain	#5	Black	100m	19YKK CNCH5 580
	Spiral Slide Single Tab.	#5	Plastic	Box 100	19YKK 5CNDF3L PLA
	Spiral Slide Single Tab.	#5	Nickel	Box 100	19YKK 5CNDF3L NIC
	Spiral Slide Double Tab	#5	Nickel	Box 100	19YKK 5CND3WL NIC
	Spiral Chain	#3	White	200m	19YKK CFCH3 501
	Spiral Chain	#3	Beige	200m	19YKK CFCH3 573
	Spiral Chain	#3	Black	200m	19YKK CFCH3 580
	Spiral Slide Type G	#3	Bronze	Box 100	19YKK 3CFD58V BNP

ZIPPER FEATURES

SPIRAL TOOTH

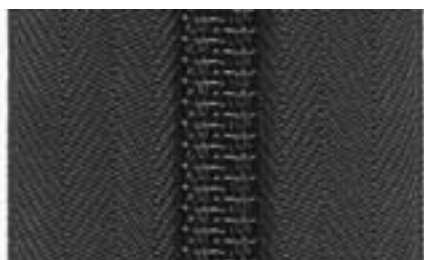

SINGLE TAB
operates from front only



DOUBLE TAB
operates from front and/or rear

PRODUCT DETAILS

VELCRO® BRAND FASTENING SYSTEMS

Product	Width	Type	Colour	Roll Length	Part #
 <p>SEW-ON A high quality hook and loop fastening system.</p>	25mm	Hook	Black	25m	19 VEL 10702
	25mm	Loop	Black	25m	19 VEL 10802
	25mm	Hook	White	25m	19 VEL 10706
	25mm	Loop	White	25m	19 VEL 10806
	50mm	Hook	Black	25m	19 VEL 11002
	50mm	Loop	Black	25m	19 VEL 11102
	50mm	Hook	White	25m	19 VEL 11006
	50mm	Loop	White	25m	19 VEL 11106
 <p>0172 Pressure Sensitive A hook and loop fastener with a high bond strength, self adhesive backing.</p>	25mm	Hook	Black	25m	19 VEL 14747
	25mm	Loop	Black	25m	19 VEL 14847
	25mm	Hook	White	25m	19 VEL 14748
	25mm	Loop	White	25m	19 VEL 14848
	50mm	Hook	Black	25m	19 VEL 15008
	50mm	Loop	Black	25m	19 VEL 15135
	50mm	Hook	White	25m	19 VEL 15009
	50mm	Loop	White	25m	19 VEL 15109
 <p>One Wrap® A back-to-back hook and loop fastening system.</p>	12mm	One-Wrap	Black	22.8m	19 VEL 189755
	12mm	One-Wrap	White	22.8m	19 VEL 170015
	25mm	One-Wrap	Black	22.8m	19 VEL 189590
	25mm	One-Wrap	White	22.8m	19 VEL 189695
	50mm	One-Wrap	Black	22.8m	19 VEL 189661
	50mm	One-Wrap	White	22.8m	19 VEL 189699
 <p>Moulded MVA8* A high strength hook fastener for semi permanent applications.</p>	25mm	Hook	Black	20m	19 VEL 20019
	*Comes with 0172 self adhesive backing				

Other colours, widths and VELCRO® Brand fastening systems are available on request.

PRODUCT DETAILS

NOLAN HOOK & LOOP FASTENERS

Product	Width	Type	Colour	Roll Length	Part #.
 <p>Touch Fast A standard hook & loop fastening system.</p>	25mm	Hook	Black	25m	19TCH FST 25 BLA HOO
	25mm	Loop	Black	25m	19TCH FST 25 BLA LOO
	25mm	Hook	White	25m	19TCH FST 25 WHI HOO
	25mm	Loop	White	25m	19TCH FST 25 WHI LOO
	50mm	Hook	Black	25m	19TCH FST 50 BLA HOO
	50mm	Loop	Black	25m	19TCH FST 50 BLA LOO
	50mm	Hook	White	25m	19TCH FST 50 WHI HOO
	50mm	Loop	White	25m	19TCH FST 50 WHI LOO
 <p>Touch Press A standard hook & loop fastening system with a self adhesive backing</p>	25mm	Hook	Black	25m	19TCH PRS 25 BLA HOO
	25mm	Loop	Black	25m	19TCH PRS 25 BLA LOO
	25mm	Hook	White	25m	19TCH PRS 25 WHI HOO
	25mm	Loop	White	25m	19TCH PRS 25 WHI LOO
	50mm	Hook	Black	25m	19TCH PRS 50 BLA HOO
	50mm	Loop	Black	25m	19TCH PRS 50 BLA LOO
	50mm	Hook	White	25m	19TCH PRS 50 WHI HOO
	50mm	Loop	White	25m	19TCH PRS 50 WHI LOO

TABS, LOCKS & SLIDES







Product	Step Lock	Triangle	Heavy Duty D-Ring	Tri Slide
Size/ Part #	25mm: 19 VEL 177 028	25mm: 19 VEL 177055	25mm: 19 VEL 177052	25mm: 19 VEL 177044
		50mm: 19 VEL 177172	50mm: 19 VEL 177054	50mm: 19 VEL 177047

BUCKLES & HOOKS

Product	Press Buckle	Side Release Heavy Buckle	Bungee Cord Hook
Size/ Part #	25mm: 19 VEL 177210	25mm: 19 VEL 177337	6mm: 19 VEL 177851
		50mm: 19 VEL 177344	8mm: 19 VEL 177852

PRODUCT DETAILS

'STAYPUT' FASTENERS (with Metal Tongues)

			
Product	STAYPUT VERTICAL	STAYPUT HORIZONTAL	CANVAS TO CANVAS
Details	Single (barrel length 12mm)	Single (barrel length 12mm)	Single (barrel length 12mm)
Part #	White: 10 STAVSM	White: 10 STAHSM	White: 10 STACCSM
	Black: 10 STAVSBM	Black: 10 STAHSBM	Black: 10 STACCSBM
	Stainless Steel: 10 STAVSSS	Stainless Steel: 10 STAHSSS	–
Details	Double (barrel length 15mm)	Double (barrel length 15mm)	Double (barrel length 15mm)
Part #	White: 10 STAVDM	White: 10 STAHDM	White: 10 STACCDM
	Black: 10 STAVDBM	Black: 10 STAHDBM	Black: 10 STACCDBM
			
Product	CURVED BASE PLATE	NYLON HOOK	MARQUEE WALL HOOK
Details	Use with the Stayputs above	Suits SP4 eyelets	–
Part #	White: 10 STACB	White: 10 STAHK	White: 10 STAMHK
	Black: 10 STABB	Black: 10 STAHKB	Black: 10 STAMHKB

DOME HOOKS

Designed for securing fabric to a flat surface in either horizontal or vertical applications.



Horizontal

Colour

Part # (Horizontal)

Part # (Vertical)



Black

10 STADHHB

10 STADHVB

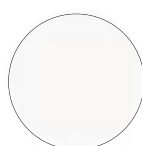

White

10 STADHH

10 STADHV



Ivory

10 STADHHI

10 STADHVI



Cement

10 STADHHCE

10 STADHVCE



Vertical

Colour

Part # (Horizontal)

Part # (Vertical)



Clay

10 STADHHCL

10 STADHVCL



Terracotta

10 STADHHT

10 STADHVT









Green

10 STADHHG

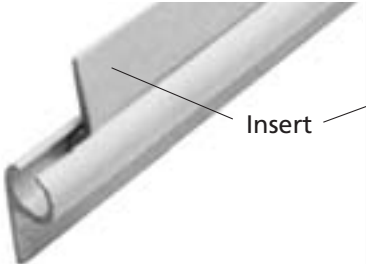





10 STADHVG

PRODUCT DETAILS

SAIL & ROPE TRACK

Product	 SIDE MOUNT	 SIDE MOUNT WITH COVER STRIP	 TOP MOUNT	
Part # (Track)	Small: 10 OPT OP60 Medium: 10 OPT OP64	10 OPT OP61	10 OPT OP62	
(Insert)	Small: 10 OPT OP60/61 INS	Medium: 10 OPT OP63	10 OPT OP63	
Details	Flexible plastic. UV stabilised. Supplied with track and insert in either vertical (side mount) or horizontal (top mount) style. Length: 6 metres.			
Product	 SINGLE ROPE TRACK	 DOUBLE ROPE TRACK	 ROPE TRACK SLIDES	 EASYSLIDE CLEAR PVC BEAD
Part #	29 TRKSIN MILL	29 TRKDBL MILL	White: 10STA RTS Black: 10STA RTS B	29 PVCBEA EAS
Details	Aluminium mill finish. Length: 6 metres. Also available in colours		Sold in box of 100	Roll length: 50 metres

KEDAR

Product	 DOUBLE SIDED BLACK	 DOUBLE SIDED WHITE	 SINGLE SIDED WHITE
Part #	19 KED 7.5 DOU BLA	19 KED 7.5 DOU WHI	19 KED 7.5 SIN WHI
Details	A tape and spline system used for attaching textiles into sail track. Can be sewn or high frequency welded. Spline diameter: 7.5mm. Roll length: 100 metres.		
Also available on indent	 7.5mm double sided beige	 11mm double sided white	 13mm double sided white

PRODUCT DETAILS

TONNEAU COVER FITTINGS

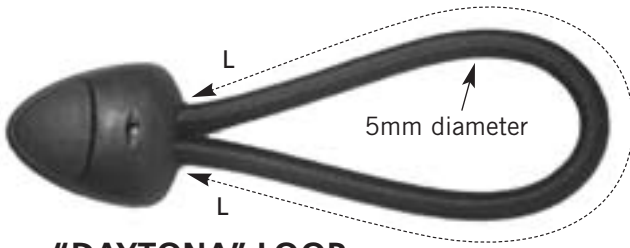

"DAYTONA" LOOP

Stylish aerodynamic design loop with hidden fastener. Attaches with 550A durable.

Size (L)	Colour	Part #
130mm	Black	03 DAY 130B
150mm	Black	03 DAY 150B
150mm	White	03 DAY 150W
170mm	Black	03 DAY 170B
170mm	White	03 DAY 170W
190mm	Black	03 DAY 190B
190mm	White	03 DAY 190W
210mm	Black	03 DAY 210B

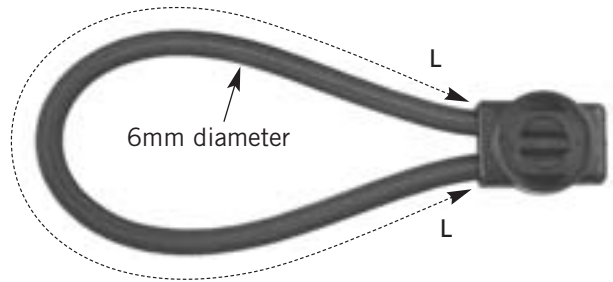

FORD TONNEAU LOOP

Comes with plastic retaining clip.

Size (L)	Colour	Part #
125mm	Black	10 LOOFOR SHO
180mm	White	10 LOOFOR WHI
180mm	Black	10 LOOFOR BLA
250mm	Black	10 LOOFOR LON

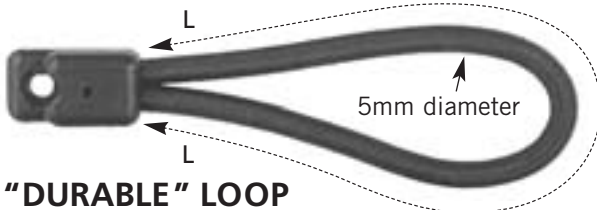

"DURABLE" LOOP

Attaches with 550A durable.

Size (L)	Colour	Part #
130mm	Black	10 LOOBF5-130
150mm	Black	10 LOOBF5-150
170mm	Black	10 LOOBF5-170
190mm	Black	10 LOOBF5-190
209mm	Black	10 LOOBF5-209
250mm	Black	10 LOOBF8-250
(Heavy Duty) – Loop width 8mm		

SHOCKCORD



Pure latex rubber coated with UV stabilised polyester yarn. 100m rolls.

Diameter	Colour	Part #
3mm	Black	19 SH03
6mm	Black	19 SH06B
6mm	White	19 SH06W
8mm	Black	19 SH08
10mm	Black	19 SH010

Product	 TONNEAU BUTTON	 ROPE HOOK (PLASTIC)	 BAR BRACKET
Part #	Black: 10 LOOFOR NB007 BLA White: 10 LOOFOR NB007 WHI	Black: 10 BOABF270 BLA White: 10 BOABF270 WHI	Secures bar to vertical face Black: 10 BOABF250

PRODUCT DETAILS

SHADECLOTH FITTINGS

(Grade 316 Stainless Steel)

EYE BOLTS – Supplied with 2 stainless steel washers and 1 stainless steel hex nut.

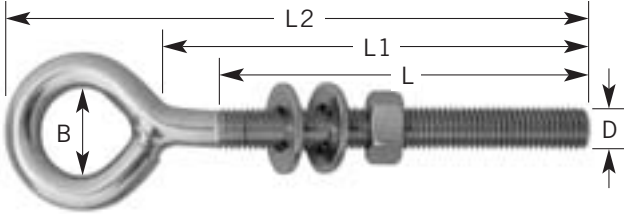

Part #	Size (mm)					
	D	L1	L2	L	B	B/S
29EYEBOL 10	10	100	145	90	21	2250Kg
29EYEBOL 12	12	120	170	107	25	3240Kg

EYE BOLTS – Collared
(with stainless steel washer and hex nut)

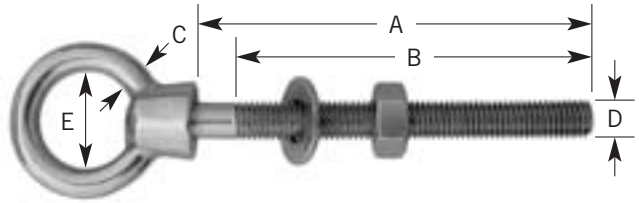

Part #	Size (mm)					
	D	A	B	C	E	B/S
29EYEBOL 10	10	100	88	8	24	2500Kg
29EYEBOL 12	12	120	105	10	30	3600Kg

SNAP HOOK WITH EYE

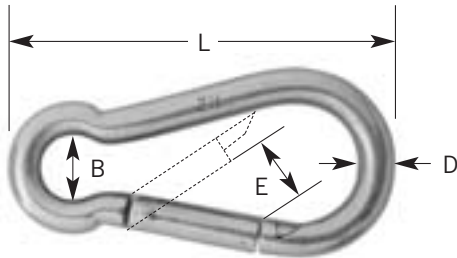

Part #	Size (mm)				
	L	D	B	E	B/S
29HOOSTASNA	50	6	7	7	450Kg

EYE NUTS – (with a female metric thread)

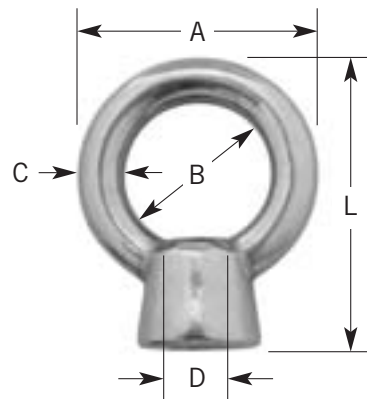

Part #	Size (mm)					
	D	L	A	B	C	S.W.L.
29EYENUT 10	10	45	41	24	8	150Kg
29EYENUT 12	12	57	50	30	10	220Kg

SHACKLES –
(with Pin)

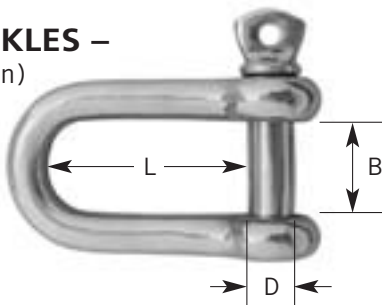

Part #	Size (mm)			
	D	L	B	B/S
29SHASTA 6	6	21	12	1800KG
29SHASTA 8	8	28	16	3500KG
29SHASTA 10	10	35	20	5400KG
29SHASTA 12	12	42	24	7200KG

DEE RINGS –

Strong 316 grade stainless steel. Argon welded non-corrosive.

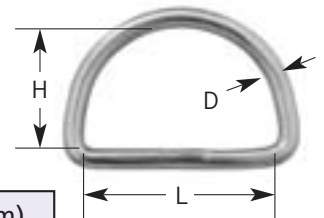

Part #	Size (mm)		
	D	L	H
29RINSTA 25	5	25	22
29RINSTA 40	6	40	35
29RINSTA 50	6	50	43

B/S – Breaking Strength S.W.L. – Safe Weight Limit

PRODUCT DETAILS

EYE & HOOK TURNBUCKLE

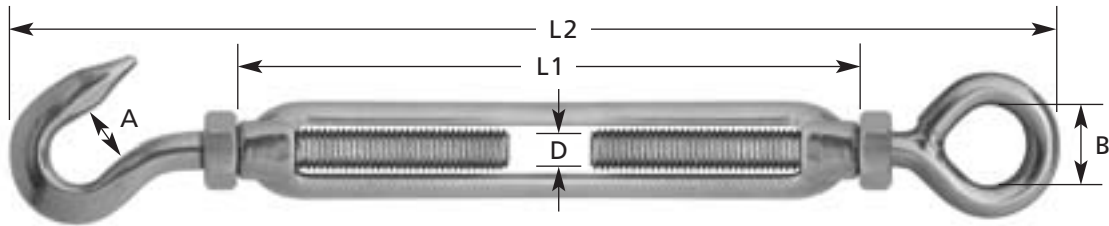

HOOK & HOOK TURNBUCKLE



EYE & EYE TURNBUCKLE



Product	Part #	Size (mm)						
		D	A	B	L1	L2 min	L2 max	B/S
EYE & HOOK	29TURSTA 8	8	11	14	120	200	290	2500Kg
	29TURSTA 10	10	12	16	150	245	350	3900Kg
	29TURSTA 12	12	14	19	200	325	470	6400Kg
HOOK & HOOK	29TURSTA 8	8	11		120	200	290	2500Kg
	29TURSTA 10	10	12		150	245	350	3900Kg
	29TURSTA 12	12	14		200	325	470	6400Kg
EYE & EYE	29TURSTA 8	8		14	120	200	290	2500Kg
	29TURSTA 10	10		16	150	245	350	3900Kg
	29TURSTA 12	12		19	200	325	470	6400Kg

SHADESAIL WEBBING

Width: 50mm. Roll Length: 100 metres.

						
Colour	Blue	Green	Beige	White	Grey	Black
Part #	19WEBSHA BLU	19WEBSHA GRE	19WEBSHA BEI	19WEBSHA WH	19WEBSHA GRY	19WEBSHA BLA

25mm width, Black or White only – Part # Black: 19WEBSHA BLA 25 White: 19WEBSHA WHT 25

BLIND FITTINGS

PRODUCT DETAILS

ZIPTRAK SYSTEM

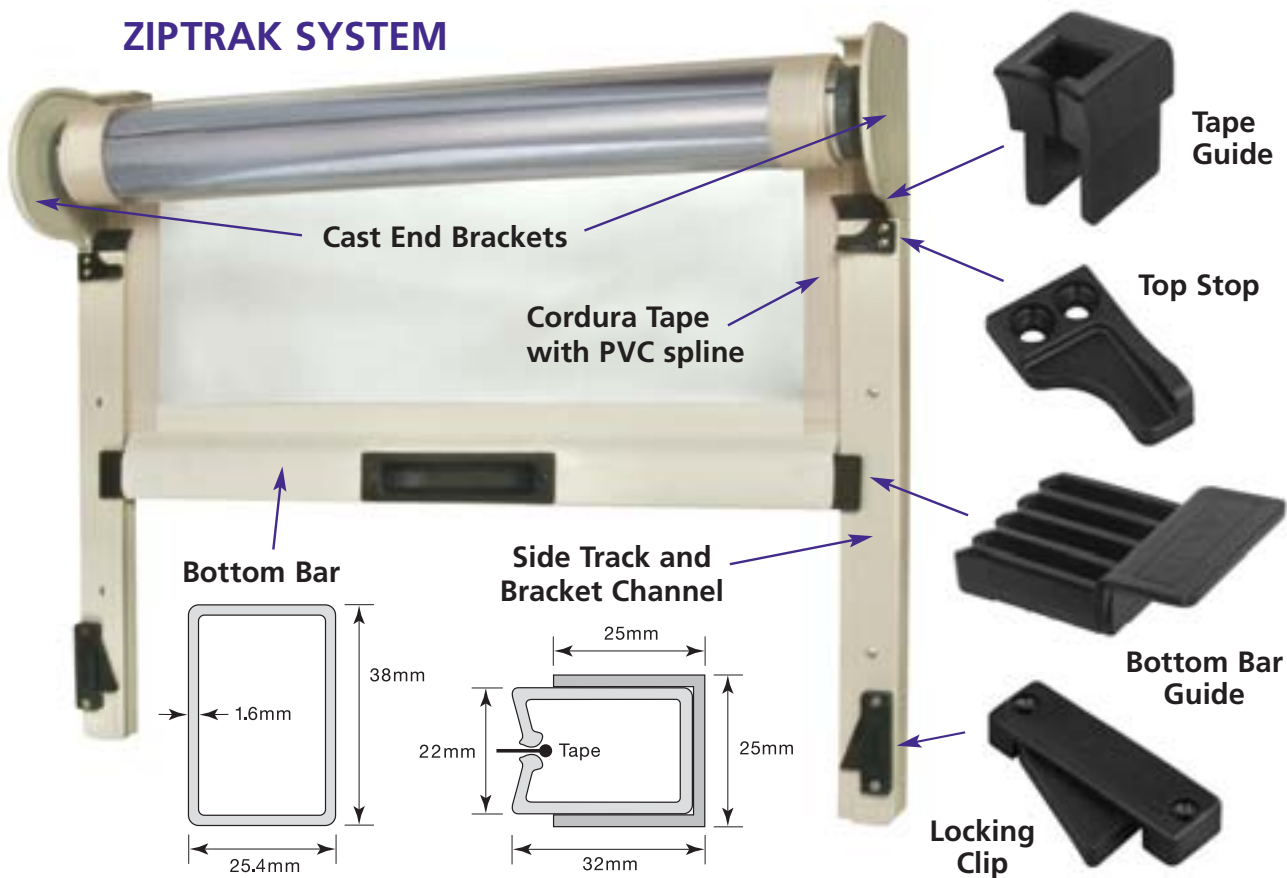

SPECIFICATIONS







Product	Description	Size/Quantity	Part #
Cast End Brackets	Brackets designed to fit into the top of the Bracket Channel and align the Keyway Tube correctly. Mill finish	Pair (left and right sides)	29ZIP D0341 MF
Cordura Tape with PVC Spline	Self-lubricating. UV stabilised. Available in White, Black or Cream.	40m rolls, or supplied cut to length	White: 29ZIP D020 Black: 29ZIP D021 Cream: 29ZIP D022
Tape Guide	UV stabilised nylon. Colour: Black	Pair	29ZIP D025
Top Stop	Suited to Pop Rivet. Prevents Bottom Bar Guide from being wound onto Keyway Tube. Colour: Black	Pair (left and right sides)	29ZIP D0272
Bottom Bar Guide	UV stabilised polyurethane. Colour: Black	1 Pair (set of 4)	29ZIP D026
Locking Clip	Keeps blind under tension in a closed position. Colour: Black	Pair (left and right sides)	29ZIP D0351
Side Track and Bracket Channel (sold as a set)	Extruded aluminium. Mill finish. Suited to powder coating.	Side Track: 2.5m	29ZIP D001 2.5MF
		Side Track: 3.0m	29ZIP D001 3.0MF
		Side Track: 5.5m	29ZIP D001 5.5MF
		Bracket Channel: 2.5m	29ZIP D B10 2.5MF
		Bracket Channel: 3.0m	29ZIP D B10 3.0MF
		Bracket Channel: 5.5m	29ZIP D B10 5.5MF
NOTE:	Keyway Tube and Springs assembly is recommended with the ZipTrak system.		

BLIND FITTINGS – PRODUCT DETAILS			
Product	 DIE CAST ALUMINIUM SINGLE PULLEY	 DIE CAST ALUMINIUM DOUBLE PULLEY	 FLUSH MOUNT WITH SNAP HOOK
Part #	10 MOSAP5-CH7	10 MOSAP6-CH7	Mount: 29 FLU MOU Hook: 29 HOO STA SNA
Details	Pulley and adaptor sold as a set. Use with 6mm pulley cord		Stainless steel snap hook
Product	 PLASTIC SINGLE PULLEY	 PLASTIC DOUBLE PULLEY	 SPRING LOADED BLIND STRAPS
Part #	Pulley: 10 MOSAP (colour) Single Adaptor: 10 MOSCH (colour)	Pulley: 10 MOSAP (colour) Double Adaptor: 10 MOSCH (colour)	29 STR BLA
Details	Made from a resilient co-polymer material in 4 colours: White, Beige (pictured), Dark Green, Black. Use with 6mm pulley cord		Available in boxes of 10
Product	 PULLEY CORD 6mm braided polyester	 SILVER ROPE	 CAM BUCKLE
Part #	Black: 29 ROPBRD BLA White: 29 ROPBRD WHI Beige: 29 ROPBRD BEI	6mm: 29 ROPSIL 6 8mm: 29 ROPSIL 8 10mm: 29 ROPSIL 10	10 CAMBUC 25
Details	Roll length 200m	250 metre coil	Suit 25mm webbing
Product	 PLASTIC END CAPS	 ROUND TUBE	 BREACHING STAPLE
Part #	29 CAPEND	29 PIPLIG	29 STABRE
Details	Available in Boxes of 50	33.7mm O/D. Galvanised steel. Length: 6.5 metres. 2mm wall	For affixing blind to ground. Available in boxes of 10

PRODUCT DETAILS

PLASTIC MARINE CANOPY FITTINGS

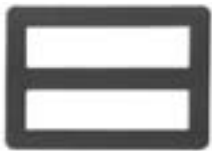
(All fittings available in black and white)

Product	 Deck Mount	 Tube End	 Knuckle	
Part #	Black: 10 OPTOP 16 White: 10 OPTOP 17	Size A: Black: 10 OPTOP 14 White: 10 OPTOP 15 Size B: Black: 10 OPTOP 12A White: 10 OPTOP 13A Size C: Black: 10 OPTOP 12 White: 10 OPTOP 13	20mm Black: 10 OPTOP 10 20mm White: 10 OPTOP 11 25mm Black: 10 OPTOP 08 25mm White: 10 OPTOP 09	
Details	Secures bow to deck	Tube diameter/thickness: Size A: 20mm x 1.6mm Size B: 25mm x 3.0mm Size C: 25mm x 1.6mm	Tube mid mount	
Product	 Side Mount	 Thumbscrew	 Buckle	 'D' Buckle
Part #	Black: 10 OPTOP 31 White: 10 OPTOP 32	Black: 10 OPTOP 21 White: 10 OPTOP 22	Black: 10 OPTOP 23 White: 10 OPTOP 24	Black: 10 OPTOP 25 White: 10 OPTOP 26
Details	Secures bow to vertical deck	Alternative to permanent screw in mounts or knuckles	Suits 25mm webbing. Adjustable webbing clip	Suits 25mm webbing. Adjustable webbing clip

BOAT FRAME KITS

Boat frame kits contain four tube ends, two knuckles, two deckmounts, two bow joiners, one 20mm mainbow (two halves), one 20mm auxiliary bow (two halves).

A standard adjustable bow kit for a typical application as shown here, is available in two sizes:

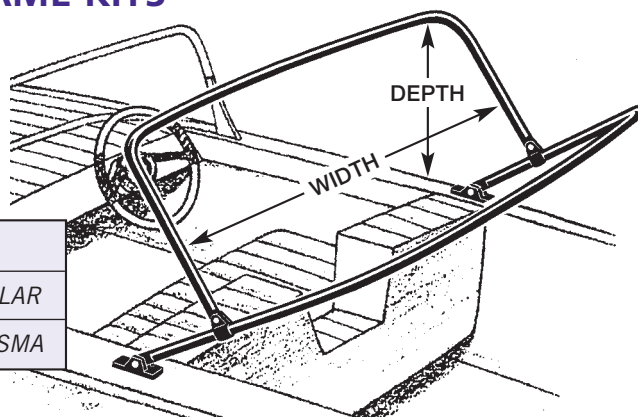











Size	Max Width	Max Depth	Part #
Large	1800mm	1300mm	10 BOABOW LAR
Small	1450mm	850mm	10 BOABOW SMA

PRODUCT DETAILS

STAINLESS STEEL MARINE CANOPY FITTINGS

(Marine grade 316)

Product	 Heavy Duty Side Mount	 Side Mount	 Deck Mount
Part #	10 OPT S9894	10 OPT S9731	90°: 10 OPT S9732 Angled: 10 OPT S9734 Concave: 10 OPT S9743
Details	Heavy duty vertical surface mount	Vertical surface mount	90°: Square vertical surface mounting Angled: Offset or angled vertical surface mounting Concave: Tube mounting
Product	 Deck Hinge Universal	 Top Cap	 Top Slide
Part #	10 OPT S9712	(ID) 25mm: 10 OPT S9740 (ID) 32mm: 10 OPT S9789H	(ID) 25mm: 10 OPT S9736 (ID) 32mm: 10 OPT S9714H
Details	Multi angle surface hinge	Fixes tube to side & deck hinge	Tube mid mount
Product	 Pelican Hook	 Spring Snap	 Wire Thimble
Part #	10 OPT S3902	10 OPT S2050	10 OPT S2603
	 Wire Eye Strap		10 OPT S3105



XTREME SEAL

Xtreme Seal is a flexible edge seal profile that can be sewn or glued. It is designed to seal the air gap between a flexible textile and a hard surface. Typical applications include marine windscreens and covers, camping equipment and automotive soft tops.

Roll Length: 15 metres

Part # Black: 03 XTR BLA White: 03 XTR WHI

AUTOMOTIVE TRIM PROFILES

PRODUCT DETAILS

GLASS RUN CHANNELS

Part #	19 RAR31 025	19 RAR39 069R	19 RAR39 500

EDGE CAPPING

Plain Pinchweld

<p>Standard size suits panel up to 5mm thick</p>	<p>Mini size suits panel up to 3mm thick</p>
--	--

BOOT SEALS

<p>50 metre coil</p>	
----------------------	--











Colour	Black, White, Grey	Black	Black	Black
Part #	Black: 19 RAR66 8295 White: 19 RAR66 8296 Grey: 19 RAR66 8325	19 RAR66 035	19 RAR66 016	19 RAR60 051

DOOR SEALS







Pinchweld with D Rubber. Available in Black only.

<p>Large</p>	<p>Medium</p>	<p>Mini</p>
--------------	---------------	-------------

Part #	19 RAR60 054	19 RAR60 055N	19 RAR60 053
--------	--------------	---------------	--------------

UPHOLSTERY & TRIM SUPPLIES			
Product	 SEAT PIPING CORD	 PRE-COVERED VINYL SEAT PIPING CORD	 CONCEALED ('HIDEM') BINDING
Part #	19 PIP HOL (size)	19 VSP (colour)	19 HID (colour)
Details	Hollow PVC. Diameter: 2mm, 3mm. Roll length: 1000m.	Roll length: 200m.	Roll length: 50m.
Colours	Black	Black, White, Dark Grey, Light Grey, Marine Red, Marine Blue, Dark Red, Dark Blue, Dark Brown, Mid Brown, Beige. 	
Product	 AIR STAPLE GUN	 STAPLES (Type 80 series)	 HOG RING FASTENERS
Part #	19 AIRTT 80/16	Galvanised: 19 AIR80 (size) GAL S/Steel: 19 AIR80 (size) STA	1,000 rows: 19 AIRRP 22 7kg pack: 19 AIRCL 227 5,000 rings: 19 ABLHOG ROW 5000
Details	Suits type 80 series staples.	Galvanised: 6mm, 10mm S/Steel: 4mm, 6mm, 10mm	Available in: Box of 1,000 or 5,000 rings (magazine), box of 7kg loose.
CHAIR BACKING & UNDERLAY			
Product	 Hessian	 Hessian ('Jute') Webbing	 Calico (Unbleached)
Part #	19 HES 18	19 WEB JUT	19 CAL52/52 137
Details	Weight: 18oz Roll length: 50m	Roll length: 50m Width: 50mm	Roll length: 100m Roll width: 137cm
Product	 Synthetic Calico		
Part #	Black: 19 BARSPU BLA White: 19 BARSPU WHI		
Details	Non-woven polyester. Roll length: 100m. Roll width: 160cm.		

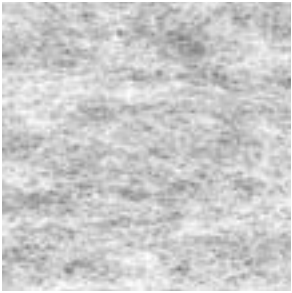
UPHOLSTERY & TRIM SUPPLIES

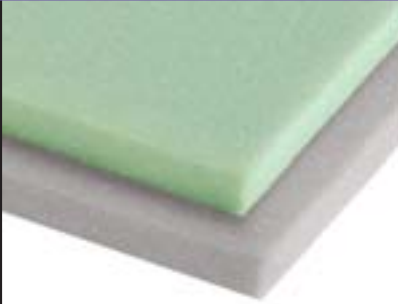
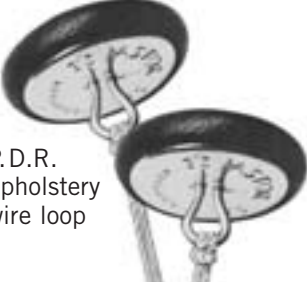
Product	 SPRAY CONTACT ADHESIVE	 SPRAY CONTACT ADHESIVE	 SPRAY PRESSURE SENSITIVE ADHESIVE
Part #	19 ADH NOL ADH	19 ADH PB 925	19 ADH PB 924
Details	20 litre drum	482g aerosol can	482g aerosol can
Product	 PLEXUS CLEAR PVC CLEANER	 SILICONE SPRAY	 BONDED POLYESTER FILLING
Part #	198g can: 19 PLE 198 368g can: 19 PLE 368	19 HEL REL 4000	19 TONBON POL
Details	CFC free spray can. Available in boxes of 12 or individually.	300g can	200gsm density. Roll length: 30m. Width: 152cm
Product	 POLYURETHANE ROLL FOAM	 POLYURETHANE SHEET FOAM	 ASTOR UPHOLSTERY BUTTONS
Part #	<i>Refer your local Nolan branch – Sizes, grades and stock holdings can vary depending on your local Nolan branch.</i>		01 BUT PDR (size)
Details	Medium density roll foam with a cerax backing suitable for seating cover underlay. Sizes available (mm): 6, 9, 12.	Green: Premium grade suitable for upholstery seating. Grey: Medium grade suitable for seat backs and mattresses. Thicknesses available (mm): 25, 50, 75, 100, 125.	Sold as a set (dome & back). Suit Astor brand buttoning machines. Other button types, machines, dyes, cutters and spares available only on indent.